

---

Electronic Thesis and Dissertation Repository

---

8-11-2015 12:00 AM

## Passive Acoustic Emissions Monitoring of Fluidized Bed Pellet Coating

Taylor Sheahan  
*The University of Western Ontario*

Supervisor  
Dr. Lauren Briens  
*The University of Western Ontario*

Graduate Program in Biomedical Engineering  
A thesis submitted in partial fulfillment of the requirements for the degree in Master of Engineering Science  
© Taylor Sheahan 2015

Follow this and additional works at: <https://ir.lib.uwo.ca/etd>



Part of the [Biomaterials Commons](#)

---

### Recommended Citation

Sheahan, Taylor, "Passive Acoustic Emissions Monitoring of Fluidized Bed Pellet Coating" (2015).  
*Electronic Thesis and Dissertation Repository*. 3038.  
<https://ir.lib.uwo.ca/etd/3038>

This Dissertation/Thesis is brought to you for free and open access by Scholarship@Western. It has been accepted for inclusion in Electronic Thesis and Dissertation Repository by an authorized administrator of Scholarship@Western. For more information, please contact [wlsadmin@uwo.ca](mailto:wlsadmin@uwo.ca).

PASSIVE ACOUSTIC EMISSIONS MONITORING OF FLUIDIZED BED PELLET  
COATING

(Thesis format: Integrated Article)

by

Taylor Sheahan

Graduate Program in Biomedical Engineering

A thesis submitted in partial fulfillment  
of the requirements for the degree of  
Master of Engineering Science

The School of Graduate and Postdoctoral Studies  
The University of Western Ontario  
London, Ontario, Canada

© Taylor A. Sheahan 2015

## Abstract

Passive acoustic emissions were assessed for their potential as a non-invasive monitoring tool for the coating of pellets in a fluidized bed. Pharmaceutical pellets are small spherical particles that contain an active ingredient. They are film coated for the purpose of modified drug release and packed into capsules as a multiple unit dosage form. A more reliable monitoring and control method is desired to ensure the appropriate drug release profile is achieved by minimizing variations within and between coated pellets.

Microphones attached to the exterior of a conical top spray fluidized bed measured acoustic emissions produced from the coating process. Statistical analysis of the signals was shown to provide information on fluidization quality and nozzle performance, while the amplitude of the acoustic emissions was shown to correspond to an increase in pellet film coat thickness. Overall, passive acoustic emissions reflected changes in process dynamics and particle interactions, indicating the ability to monitor fluidized bed pellet coating and potentially for the determination of a desired coating end-point.

**Keywords:** Fluidization, top spray coating, acoustic monitoring, pellets, film thickness, process analytical technology

## Co-Authorship Statement

Chapters 3 and 4 are research studies that have been published or accepted for publication in a peer-reviewed journal. The authors' individual contributions are stated below for each journal article.

### **Chapter 3: Passive acoustic emissions monitoring of the coating of pellets in a fluidized bed – A feasibility analysis**

*Authors: Taylor Sheahan, Lauren Briens*

*Status: Published in Powder Technology, 283 (2015) 373-379*

All experimental work, including coating trials and acoustic data acquisition, was performed by Taylor Sheahan. Data was analyzed by Taylor Sheahan under the supervision of Lauren Briens, who provided assistance with the interpretation of data. Manuscript was written and edited by Taylor Sheahan and reviewed by Lauren Briens.

### **Chapter 4: Passive acoustic emissions monitoring of pellet coat thickness in a fluidized bed**

*Authors: Taylor Sheahan, Lauren Briens*

*Status: Accepted for publication in Powder Technology*

All experimental work, including coating trials, acoustic data acquisition and supplemental work, was performed by Taylor Sheahan. Data was analyzed by Taylor Sheahan under the supervision of Lauren Briens, who provided assistance with the interpretation of data. Manuscript was written and edited by Taylor Sheahan and reviewed by Lauren Briens.

## Acknowledgments

I would like to thank my supervisor Dr. Lauren Briens for her support throughout the course of my master's program. Her encouragement and guidance has made the completion of this thesis possible and I am very grateful for my time spent here at Western University. I would also like to thank Dr. Franco Berutti and Dr. Paul Charpentier for being a part of my advisory committee.

I would like to acknowledge the Natural Sciences and Engineering Research Council of Canada (NSERC) and The University of Western Ontario Graduate Thesis Research Award Fund (GTRAF) for all financial contributions and support.

Thank you to Clayton Cook and the University Machine Services for their help with modifying the fluidized bed, as well as to Brian Dennis and Souheil Afara for their assistance. I would also like to thank Heather Bloomfield of Surface Science Western for examining the glass pellets.

I would like to thank the Biomedical Engineering staff and faculty for their support and provided education. Also, thank you to my lab members: Allison Crouter, Aveen Alkhatib, and Breanna Bowden-Green. Finally, the encouragement received from my family and friends was greatly appreciated and I thank everyone for their support.

## Table of Contents

Abstract .....	ii
Co-Authorship Statement.....	iii
Acknowledgments.....	iv
Table of Contents .....	v
List of Tables .....	viii
List of Figures .....	ix
Chapter 1 .....	1
1 Introduction .....	1
1.1 Pharmaceutical Coating .....	1
1.1.1 Purpose.....	1
1.1.2 Coating Processes .....	1
1.2 Fluidized Bed Coating .....	3
1.3 Particle Coating Phenomena .....	5
1.4 Influence of Process Parameters .....	6
1.5 Difficulties Associated with Fluidized Bed Coating .....	8
1.6 Thesis Objectives .....	8
1.7 Thesis Overview .....	9
1.8 References.....	10
Chapter 2.....	14
2 Methods for Evaluating and Monitoring Fluid Bed Coating of Pharmaceutical Pellets .....	14
2.1 Introduction.....	14

2.2	Methods for Monitoring Fluidization Regimes .....	15
2.2.1	Pressure Fluctuation Analysis.....	16
2.3	Methods for Evaluating the Coating of Pharmaceutical Pellets .....	17
2.3.1	Traditional Methods.....	17
2.3.2	Image Analysis Methods.....	17
2.3.3	Spectroscopic Methods .....	21
2.3.4	Evaluating Colour .....	21
2.4	Methods for Monitoring the Coating of Pharmaceutical Pellets .....	22
2.4.1	Spectroscopic Methods .....	22
2.4.2	Passive Acoustic Emissions.....	24
2.4.3	Visiometric Process Analyzers .....	25
2.5	Conclusions.....	25
2.6	References.....	26
Chapter 3.....		33
3	Passive Acoustic Emissions Monitoring of the Coating of Pellets in a Fluidized Bed – A Feasibility Analysis .....	33
3.1	Introduction.....	33
3.2	Materials and Methods.....	36
3.2.1	Fluidized Bed .....	36
3.2.2	Coating Experiments.....	37
3.3	Results.....	38
3.4	Discussion.....	45
3.5	Conclusions.....	49
3.6	References.....	49

Chapter 4.....	53
4 Passive Acoustic Emissions Monitoring of Pellet Coat Thickness in a Fluidized Bed	53
4.1 Introduction.....	53
4.2 Materials and Methods.....	57
4.2.1 Fluidized Bed.....	57
4.2.2 Coating Experiments.....	58
4.2.3 Acoustic Data Acquisition.....	59
4.2.4 Signal Analysis.....	60
4.2.5 Supplemental Experiments.....	60
4.3 Results.....	61
4.4 Discussion.....	69
4.5 Conclusions.....	73
4.6 References.....	74
Chapter 5.....	80
5 General Discussion and Conclusions.....	80
5.1 Acoustic Monitoring.....	80
5.1.1 Feasibility Analysis.....	80
5.1.2 Monitoring of Pellet Coat Thickness.....	81
5.2 Relevance to the Pharmaceutical Industry.....	83
5.3 Future Work.....	83
5.4 Conclusions.....	84
5.5 References.....	85
Curriculum Vitae.....	86



## List of Tables

Table 4-1: Material properties of uncoated glass pellets and Cellets® .....	59
Table 4-2: Coating solution applied at each coating stage for Trial 1, Trial 2 and Trial 3.....	59

## List of Figures

Figure 1-1: Gas-solid fluidization regimes (image adapted from [14]).....	4
Figure 3-1: Schematic of top spray fluidized bed with instrumentation.....	36
Figure 3-2: Coating timeline - B: Baseline, C: Coating Period, D: Drying Period, S: Sample .....	38
Figure 3-3: Measured (a) and theoretical (b) film coat thickness per pellet.....	39
Figure 3-4: Operational superficial gas velocity compared to theoretical minimum fluidization velocity .....	40
Figure 3-5: Estimated drying rate .....	41
Figure 3-6: Measured pressure drop across the bed.....	41
Figure 3-7: Raw acoustic emissions signals obtained at the exhaust (a), interface (b) and grid (c).....	43
Figure 3-8: Standard deviation of the acoustic emissions signals obtained at the exhaust (a), interface (b) and grid (c) .....	44
Figure 4-1: Schematic of the top spray fluidized bed with equipment.....	57
Figure 4-2: Measured (a) and theoretical (b) coat thickness per pellet at each coating stage	62
Figure 4-3: Scanning electron microscopy images of uncoated pellets (a,b), partially coated pellets (c,d) and coated pellets (e,f) at 1000x and 5000x magnification .....	63
Figure 4-4: Magnitude of the raw acoustic emissions signal for Trial 1: coating stage 1 (a), coating stage 2 (b), coating stage 3 (c) and coating stage 4 (d) over a 2 minute interval at a superficial gas velocity of 1.82 m/s .....	64
Figure 4-5: Amplitude of acoustic emissions produced at each coating stage and varying superficial gas velocities.....	65

Figure 4-6: Amplitude of acoustic emissions produced from a single glass pellet or group of glass pellets with increasing pellet mass.....	66
Figure 4-7: Raw acoustic emissions signal of a single pellet colliding with a metal plate and 10 pellets colliding with a metal plate .....	66
Figure 4-8: Raw acoustic emissions signal of a single pellet colliding with a metal plate (a) and a single pellet colliding with a sugar coated metal plate (b).....	67
Figure 4-9: Avalanche time of coated pellets at different wetness levels compared to the baseline avalanche time of uncoated glass pellets .....	68
Figure 4-10: Magnitude of the raw acoustic emissions signal for Cellets <sup>®</sup> fluidized at an operational superficial gas velocity of 1.12 m/s .....	69

## Chapter 1

### 1 Introduction

#### 1.1 Pharmaceutical Coating

##### 1.1.1 Purpose

Pharmaceutical coating is an important step in the manufacturing of solid oral dosage forms influencing final product quality and overall function. The applied coating surrounds the tablet or pellet core to protect the drug from heat, moisture and light, to provide mechanical strength, to improve the aesthetic appearance of the dosage form, and to control the dissolution profile of the active ingredient [1].

Pellets, defined as small spherical particles between 100 to 1000  $\mu\text{m}$  in diameter, contain the active ingredient or drug. They are often film coated and packed into capsules as a multiple unit oral dosage form. Such dosage forms have a variety of advantages over the conventional tablet, as each individual pellet contains a lower dose of the active ingredient. This leads to minimal variations in gastro-intestinal transit time, the ability to prevent dosage dumping and improved flexibility in drug formulation and design [2]. The release rate of the active ingredient is highly dependent on the properties of the film coating, including coat uniformity, coat thickness and overall coat quality [3-5].

The coating process varies for tablets and pellets mainly due to their large difference in size. It is often more difficult to apply uniform coating to the tablet core compared to the much smaller pellet. The larger surface area of the tablet corresponds to an increase in intra- and inter- film coat variation. Therefore, the consequence of non-uniform coating is minimized for multiple unit dosage forms containing coated pellets compared to coated tablets.

##### 1.1.2 Coating Processes

The coating process takes place in either a fluidized bed or a rotated drum pan coater. Fluidized bed configurations vary depending on the location of the spray nozzle: top spray, bottom spray or tangential spray. All coating processes involve the spraying of a

polymer solution onto the tablet or pellet core followed by a drying period. Each process is associated with advantages and disadvantages specific to each coating type.

In a top spray fluidized bed, the nozzle is placed at a specific height above the particle bed. This type of coating is known for its large capacity and accessible spray nozzle [1], which may be easily replaced if clogged potentially minimizing the number of discarded batches. Alternatively, top spray coating is also associated with poor efficiency and coat quality due to random particle movement, leading to an uneven distribution of the film coat among the particles [1,6]. The more complex fluidization conditions correspond to an increased risk for partial or complete bed defluidization, resulting in non-uniform growth rates and affecting the release profile of the active ingredient [7].

Bottom spray fluidized beds inject the spray from a nozzle located at the bottom of the column. The increased potential for particle agglomeration due to a high concentration of wet particles near the bottom of the bed is a main issue for this type of coating. To improve process efficiency, bottom spray fluidized beds typically include the addition of a Wurster insert [8]. The insert improves particle circulation leading to better drying rates and coat uniformity, minimizing the potential for particle agglomeration [1].

The rotating spray fluidized beds include a tangential spray coating system equipped with a rotating disk. The rotating configuration improves air flow producing coated particles of a greater density and very spherical in shape [1]. The rotating disk agitates the unit restricting the type of materials to be coated, as the particles must withstand the rotational forces.

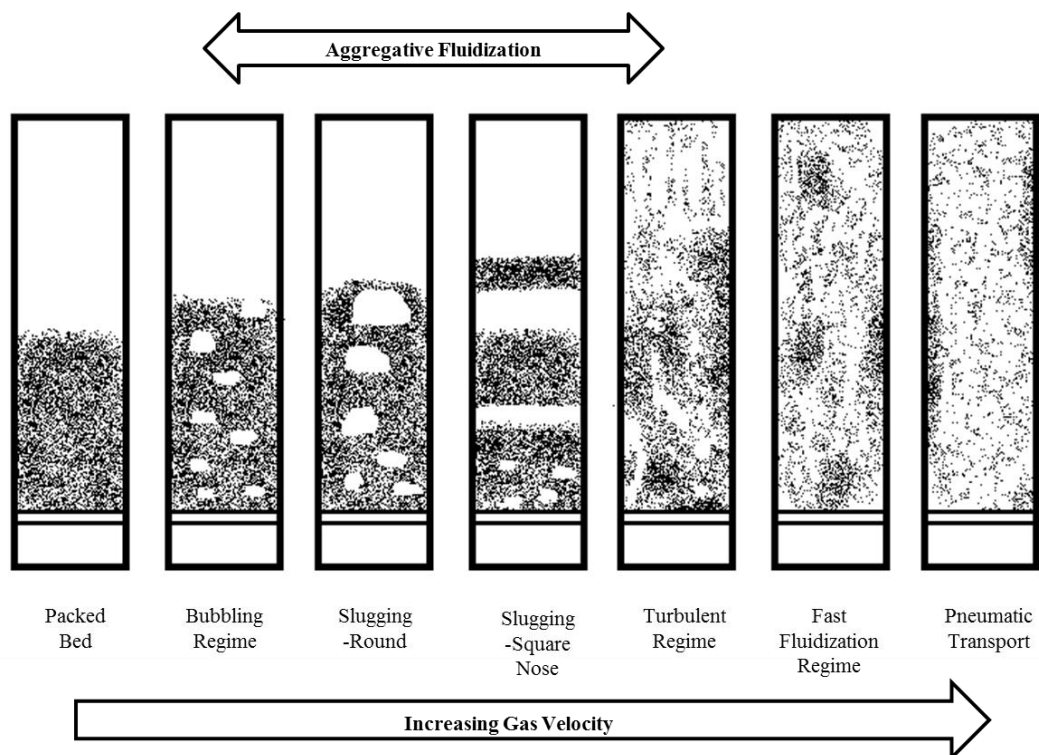
Particles coated in a rotating drum are performed in a perforated or non-perforated pan coater. An atomized coating solution is sprayed onto the particle surface. As the particles tumble within the drum, they pass through a spraying zone, followed by a drying zone [9]. Alternation between these zones is continued until a desired coat thickness is achieved. Particles coated in a rotated drum must flow easily to ensure the coat is uniformly applied, limiting the types of particles used.

In general, pan coating is preferred for the larger solid dosage forms, such as tablets, as these larger particles are often heavier and more difficult to fluidize but tumble easily in a rotated drum. Fluidized bed coating is better suited for the much lighter, smaller dosage forms such as pellets, as these particles are easier to fluidize resulting in good particle mixing.

## 1.2 Fluidized Bed Coating

A number of industries, including the pharmaceutical, cosmetic, food, chemical and agricultural industries, have implemented fluidized bed coating to provide a variety of different functions [10]. Coating is performed as a batch process, resulting in expensive and inefficient production processes [1]. Improvements to process monitoring and control have the potential to minimize the number of failed batches and loss of product, corresponding to more cost-effective manufacturing.

Fluidized bed coating involves the interaction of all three phases; gas (fluidizing/drying air), liquid (coating spray) and solid (particles) [1]. An atomized liquid spray, consisting of a solute and solvent, is sprayed onto a fluidized particle bed. The liquid impacts and spreads onto the particle surface forming a coating film as the solvent evaporates, leaving behind the solute to act as a coating medium around the particle core. Particle fluidization is an important principle of the coating process to ensure good particle mixing and good heat and mass transfer rates, influencing the final product quality. Different fluidization regimes have been identified by various authors [1,7,11-14] for gas-solid systems, summarized in Figure 1-1.



**Figure 1-1:** Gas-solid fluidization regimes (image adapted from [14])

In the 1970's, Geldart predicted the fluidization behaviour of different particles by classifying them into four different groups based on particle size and density [12]. Group A particles included fine powders that easily fluidize, resulting in good particle mixing. Group B particles result in bubbling fluidization behaviour and are defined as “sand-like” particles. Fine, cohesive particles difficult to fluidize are classified in Group C. Large particles that fluidize poorly are classified as Group D. More detail regarding fluidization behavior is described by Kunii et al. [13].

Particle fluidization is dependent on the inlet air velocity, as well as particle density, size and shape. To maintain a properly fluidized bed, the appropriate superficial gas velocity is required. Geldart's classification system provides a simple method for predicting the behaviour of particles in a fluidized bed. As well, the minimum fluidization velocity may be estimated using theoretical calculations, such as Ergun's equation [15].

Fluidized beds are chosen for their high heat and mass transfer rates, uniform temperature distribution, minimal pressure drop, good particle mixing and ability to perform multiple

unit operations in a single vessel including mixing, drying and coating [1,10]. On the contrary, operating a fluidized bed is very complicated, especially with the addition of a liquid solution. A large number of influential and interdependent process- and physicochemical- related parameters add a degree of complexity to process control. Large-scale productions typically rely on trial and error, or operator knowledge and experience, for effective operation. To improve the operation of fluidized bed coating in terms of process efficiency and stability a better understanding of particle growth mechanisms are required.

### 1.3 Particle Coating Phenomena

The interaction of gas, liquid and solid phases result in a number of different phenomena related to particle dynamics, as well as heat and mass transfer rates. Coating is governed by particle mixing, droplet spreading on the particle surface and solvent evaporation from the particle surface [1,10]. That is, sufficient particle wetting and drying, as well as an adequately fluidized bed, are required for coating to occur.

Particle mixing is promoted by the fluidizing air, allowing for good heat and mass transfer rates. Effective fluidization allows for the coating solution to be transferred between particles, contacting all surfaces as the particles move and interact with each other within the bed. Spreading of the coating droplet on the particle surface is important to the success of the coating process. The wetting energy required for droplet spreading is dependent on the contact angle between the gas, liquid and solid phases, which in turn is dependent on the inherent characteristics of the spraying liquid and particle surface [1]. Numerous studies have focused on powder wettability related to droplet spreading and its influence on particle coating and granulation processes [16-21]. Evaporation of the solvent from the particle surface allows for the solute to act as a coating medium and to form the desired coating layer around the particle core. Without solvent evaporation the particle bed may become too wet, altering the dynamics within the bed.

The chosen process parameters and specific operating conditions affect the interaction between the fluidized particle bed and atomized liquid spray, influencing process dynamics. In one case, the addition of too much liquid or the spraying of large droplets



may result in *wet quenching*, defined as the formation of liquid bridges between particles leading to the formation of large agglomerates and local defluidization [10]. A large break-up force provided by the fluidizing air may counteract the cohesive forces from the liquid bridges, breaking up large agglomerates, resulting in the fluidization of small agglomerates, which is undesirable for fluidized bed coating.

When the droplet size is smaller than the particle, two possible situations may occur: i) partial drying of the particles before they collide or ii) collision of wet particles resulting in the formation of liquid bridges [10]. In the first case, particles grow by continual layering of the coating solution, the desired phenomena for coating. In the second case, particles grow by agglomeration, eventually leading to bed defluidization, referred to as *dry quenching* [10]. For particle growth to occur by layering, the break-up forces provided by the fluidizing air must be strong enough to overcome the strength of the liquid bridges and cohesive forces formed between attached particles.

An alternative situation, referred to as *spray drying*, may occur at very high drying rates resulting in the formation of small particles as the coating droplets dry before reaching the particle surface [10]. The formation of small particles is non-ideal, affecting the dynamics of the fluidized bed and uniformity of the film coat as these particles may settle on the wet coating film.

The particle growth mechanism is highly dependent on the strength of the break-up forces provided by the fluidizing air and the strength of the cohesive forces between particles. A balance between these two forces is required to achieve a desired film coat thickness, and for coating to occur by a layering mechanism rather than particle agglomeration to dominate, which is highly dependent on the chosen operating parameters.

## 1.4 Influence of Process Parameters

The complex nature of fluidized beds has made it difficult to efficiently monitor and control the coating process. To ensure a high quality product, a variety of parameters must be taken into consideration including the inlet/outlet air temperature, inlet/outlet air

humidity, superficial gas velocity, atomizing air pressure, spray rate and droplet size [10]. Numerous studies have focused on which of these parameters have the most significant influence on fluidized bed granulation and agglomeration, specifically on particle growth and bed stability [22-26]. Such information may be related to particle coating, providing additional insight into fluidized bed process dynamics. The choice of materials used for coating and how they interact with the particles to be coated must be taken into account when determining the optimal parameters for efficient operation. Due to the interdependence of these parameters, it is important to understand how they influence one another and which parameters have the most significant impact on the coating process. A detailed study on the influence of process variables on fluidized bed coating and granulation is provided by Hemati et al. [10].

The fluidizing gas velocity is viewed as one of the most important operating parameters, influencing process stability, particle growth mechanisms and drying capacity [10]. In general, higher flow rates correspond to more efficient drying and the desired solvent evaporation favoring particle coating, while lower flow rates correspond to agglomeration and granule formation leading to bed defluidization. Granule formation at low gas velocities is assumed to result from an increase in contact between wet particles, leading to the formation of liquid bridges [10]. Alternatively, operating at too high of a gas velocity may decrease process efficiency and increase particle attrition. Therefore, it is important to operate at the appropriate fluidizing gas velocity, specific to the type of particles to be fluidized.

Atomizing spray conditions that influence fluidized bed coating include the nozzle location, droplet size, spray rate and solution viscosity. Regarding nozzle location, some studies have shown placing the nozzle near the top of the particulate bed corresponds to an increase in coating rate and efficiency [10,27]. Alternatively, placing the nozzle too close may over-wet the bed resulting in bed defluidization, as well as presenting the risk of nozzle clogging. Hemati et al. [10] suggested too great of a distance between the nozzle and particle bed to increase spray drying and the amount of coating solution lost on the column wall. Therefore, an optimum nozzle location is desired to minimize both bed defluidization and the amount of coating on the column wall.

The droplet size of the atomized coating spray in relation to the particle being coated is important to ensure particle growth occurs by a layering mechanism rather than by agglomeration. Ideally, the droplet should be smaller than that of the particle for layering to occur, preventing over-wetting of the particle bed and growth by agglomeration. This also corresponds to the chosen spray rate, where a uniform spray is desired. If the liquid is added at a faster rate than the fluidizing air is able to evaporate the solvent from the surface there is a risk of promoting particle agglomeration or bed defluidization. As well, it is important to consider the solution viscosity, as too viscous of a solution may be difficult to atomize to obtain the appropriate droplet size, affecting spray uniformity and influencing film coat quality.

## 1.5 Difficulties Associated with Fluidized Bed Coating

The complex interdependence of operating parameters for fluidized bed coating may lead to a variety of problems or undesirable phenomena. The main issues associated with fluidized bed coating are i) particle agglomeration, ii) defluidization and iii) particle attrition. Particle agglomeration results from high moisture content within the bed, negatively influencing the coating process by altering process dynamics, leading to non-uniformly coated particles and a decrease in product quality. Agglomeration is typically associated with bed defluidization, potentially leading to batch rejection and loss of product. Particle attrition takes place when the particles are vigorously circulated within the bed and pellet-pellet or pellet-equipment collisions are strong enough to damage the particles or film coating. This results in non-uniform coating, affecting the release profile of the drug *in vivo*. Therefore, it is important to minimize the occurrence of these issues during operation.

## 1.6 Thesis Objectives

The complex interaction between operating and physicochemical parameters, as well as competing phenomena in a fluidized bed, indicate the need for more sophisticated monitoring and control methods. The objective of this work was to assess the feasibility of passive acoustic emissions monitoring for the coating of pellets in a top spray fluidized bed. Multiple unit dosage forms containing coated pellets rely heavily on the properties

of the film coating for the purpose of modified drug release. This in turn is dependent on the quality of the fluidized bed, defined as a fluidized bed with good particle movement promoting an even distribution of the coating solution and efficient drying. As well, interactions between the pellets, fluidizing air and coating solution were studied to provide further insight into process behaviour.

## 1.7 Thesis Overview

Chapter 2 summarizes current techniques used to evaluate the pellet film coat in terms of coat thickness, uniformity and quality. A literature review is provided focusing on the development of monitoring methods for the coating of pellets in a fluidized bed in regards to film coat properties, as well as fluidization quality.

From the literature review, a need was identified for additional research into the study of passive acoustic emissions for monitoring fluidized bed pellet coating. Chapter 3 assesses the feasibility for using such a technique to monitor the coating of glass pellets, as a model system, in a top spray fluidized bed. Traditional evaluation methods were compared to the acoustic emissions obtained from microphones attached externally on the column. The standard deviations of the acoustic emissions signal were shown to reflect local fluidization conditions, as well as information on nozzle performance.

Building from the findings in Chapter 3, Chapter 4 examines the application of acoustic emissions monitoring to detect an increase in film coat thickness, with the overall goal of assessing the potential for determining a desired coating end-point. Analysis of the acoustic emissions amplitude was shown to reflect increases in film coat thickness. Supplemental experiments confirmed the ability of acoustic emissions to detect small changes in pellet collisions corresponding to film coat formation.

Overall, Chapter 3 and Chapter 4 indicate the potential for passive acoustic emissions to monitor fluidized bed pellet coating. The standard deviation of the acoustic emissions signal provides insight into fluidization quality, while the amplitude of the acoustic emissions signal reflects a change in film coat thickness. Therefore, passive acoustic

emissions may be used to monitor pellet fluidization or pellet coat thickness, depending on the chosen signal analysis.

Chapter 5 provides a general discussion and overall conclusions regarding the findings of this work.

## 1.8 References

- [1] E. Teunou, D. Poncelet, Batch and continuous fluid bed coating – review and state of the art, *Journal of Food Engineering*, 53 (2002) 325-340.
- [2] C.V. Liew, L.K. Wang, P. Wan Sia Heng, Development of a visiometric process analyzer for real-time monitoring of bottom spray fluid-bed coating, *Journal of Pharmaceutical Sciences*, 99 (2010) 346-356.
- [3] F. Depypere, P. Van Oostveldt, J.G. Pieters, K. Dewettinck, Quantification of microparticle coating quality by confocal laser scanning microscopy (CLSM), *European Journal of Pharmaceutics and Biopharmaceutics*, 73 (2009) 179-186.
- [4] G. Perfetti, E.V.d. Castele, B. Rieger, W.J. Wildeboer, G.M.H. Meesters, X-ray micro tomography and image analysis as complementary methods for morphological characterization and coating thickness measurement of coated particles, *Advanced Powder Technology*, 21 (2010) 663-675.
- [5] M.-J. Lee, D.-Y. Seo, H.-E. Lee, I.-C. Wang, W.-S. Kim, M.-Y. Jeong, G.J. Choi, In line NIR quantification of film thickness on pharmaceutical pellets during a fluid bed coating process, *International Journal of Pharmaceutics*, 403 (2011) 66-72.
- [6] K. Naelapää, P. Veski, J.G. Pedersen, D. Anov, P. Jørgensen, H.G. Kristensen, P. Bertelsen, Acoustic monitoring of a fluidized bed coating process, *International Journal of Pharmaceutics*, 332 (2007) 90-97.
- [7] D. Jones, Air Suspension Coating for Multiparticulates, *Drug Development and Industrial Pharmacy*, 20 (1994) 3175-3206.

- [8] D.E. Wurster, Means for applying Coating to tablets or like, Journal of the American Pharmaceutical Association, 48 (1950) 977-1011.
- [9] Y. Chen, J. Yang, R.N. Dave, R. Pfeffer, Granulation of cohesive Geldart group C powders in a Mini-Glatt fluidized bed by pre-coating with nanoparticles, Powder Technology, 191 (2009) 206-217.
- [10] M. Hemati, R. Cherif, K. Saleh, V. Pont, Fluidized bed coating and granulation: influence of process-related variables and physicochemical properties on the growth kinetics, Powder Technology, 130 (2003) 18-34.
- [11] J.R. Grace, Contacting modes and behaviour classification of gas—solid and other two-phase suspensions, The Canadian Journal of Chemical Engineering, 64 (1986) 353-363.
- [12] D. Geldart, Gas fluidisation technology, John Wiley and Sons Inc., Chichester, UK, 1986.
- [13] D. Kunii, O. Levenspiel, Fluidization Engineering (2nd Edition), Butterworth-Heinemann, Boston, 1991.
- [14] S. Dhodapkar, A. Zaltash, G. Klinzing, A primer on gas-solids fluidization, Chemical Engineering, (2012) 38-47.
- [15] S. Ergun, Fluid flow through packed columns, Chemical Engineering Progress, (1952) 89-94.
- [16] G. Buckton, Contact angle, adsorption and wettability — a review with respect to powders, Powder Technology, 61 (1990) 237-249.
- [17] K. Christoph Link, E.-U. Schlünder, Fluidized bed spray granulation: Investigation of the coating process on a single sphere, Chemical Engineering and Processing: Process Intensification, 36 (1997) 443-457.

- [18] A.-L. Bianco, C. Clanet, D. Quéré, First steps in the spreading of a liquid droplet, *Physical Review E*, 69 (2004) 016301.
- [19] S.R.L. Werner, J.R. Jones, A.H.J. Paterson, R.H. Archer, D.L. Pearce, Droplet impact and spreading: Droplet formulation effects, *Chemical Engineering Science*, 62 (2007) 2336-2345.
- [20] M.Y. Zhang, H. Zhang, L.L. Zheng, Simulation of droplet spreading, splashing and solidification using smoothed particle hydrodynamics method, *International Journal of Heat and Mass Transfer*, 51 (2008) 3410-3419.
- [21] K.P. Hapgood, L. Farber, J.N. Michaels, Agglomeration of hydrophobic powders via solid spreading nucleation, *Powder Technology*, 188 (2009) 248-254.
- [22] S. Weber, C. Briens, F. Berruti, E. Chan, M. Gray, Agglomerate stability in fluidized beds of glass beads and silica sand, *Powder Technology*, 165 (2006) 115-127.
- [23] S. Weber, C. Briens, F. Berruti, E. Chan, M. Gray, Effect of agglomerate properties on agglomerate stability in fluidized beds, *Chemical Engineering Science*, 63 (2008) 4245-4256.
- [24] E.S.K. Tang, L. Wang, C.V. Liew, L.W. Chan, P.W.S. Heng, Drying efficiency and particle movement in coating—Impact on particle agglomeration and yield, *International Journal of Pharmaceutics*, 350 (2008) 172-180.
- [25] W. Chen, S.-Y. Chang, S. Kiang, A. Marchut, O. Lyngberg, J. Wang, V. Rao, D. Desai, H. Stamato, W. Early, Modeling of pan coating processes: Prediction of tablet content uniformity and determination of critical process parameters, *Journal of Pharmaceutical Sciences*, 99 (2010) 3213-3225.
- [26] A. Burggraeve, T. Monteyne, C. Vervaet, J.P. Remon, T.D. Beer, Process analytical tools for monitoring, understanding, and control of pharmaceutical fluidized bed granulation: A review, *European Journal of Pharmaceutics and Biopharmaceutics*, 83 (2013) 2-15.

[27] P.G. Smith, A.W. Nienow, Particle growth mechanisms in fluidised bed granulation—I: The effect of process variables, *Chemical Engineering Science*, 38 (1983) 1223-1231.



## Chapter 2

### 2 Methods for Evaluating and Monitoring Fluid Bed Coating of Pharmaceutical Pellets

#### 2.1 Introduction

The coating of pharmaceutical pellets in a fluidized bed involves the spraying of an atomized liquid solution onto a heated fluidized particle bed. The process is complex and difficult to control due to a variety of interdependent variables, including process- and physicochemical- related parameters [1]. For good fluidization, it is necessary to maintain a balance between the break-up forces provided by the fluidizing air and the cohesive forces provided by the liquid spray. A stable bubbling fluidization regime allows for good heat and mass transfer rates between the gas, liquid and solid phases resulting in the formation of a film coat around the pellet core [2]. It is desirable to obtain a specific coat thickness and homogeneity to ensure coated pellets meet the required drug design specifications. Therefore, there are two important aspects to be monitored and controlled during fluidized bed pellet coating: 1) fluidization regimes and 2) specific properties of the film coat.

The most common method explored for monitoring fluidization regimes is pressure measurement analysis. Researchers have been able to use this method to detect bed defluidization, evaluate regime transitions and provide insight into fluidization phenomena [3-5].

The evaluation of film coat thickness, specifically for coated tablets, conventionally involves sample acquisition for a theoretical estimation based on a difference in coating mass and for dissolution and/or disintegration testing [6]. Considering the evaluation of coated pellets, these techniques are often associated with a variety of problems when applied to a much smaller dosage form: (i) it is difficult to accurately measure the small changes in pellet mass, (ii) intra- and inter- pellet variation is not considered, (iii) attrition of the pellet core is not accounted for, (iv) dissolution and/or disintegration testing provides indirect measurements, and (v) the required samples and off-line measurements

are invasive and time-consuming, therefore unable to provide real-time information necessary for process control.

A variety of imaging and spectroscopic techniques have been explored to improve the measurement of tablet film coatings including near infrared spectroscopy (NIR) [7-11], terahertz pulsed imaging (TPI) [12-15], Raman spectroscopy [16-18], confocal laser scanning microscopy (CLSM) [19], laser induced breakdown spectroscopy (LIBS) [20,21] and attenuated total reflection-infrared (ATR-IR) imaging [22]. In comparison, much fewer studies have been focused on the coating of pharmaceutical pellets, but also include a variety of imaging and spectroscopic methods [23-26]. Overall, these methods are still associated with in-process sampling and off-line testing, which are disruptive to the process and lead to inaccurate measurements.

Research has shifted towards the development of process analytical technologies (PATs) in accordance with the Food and Drug Administration's ICH guidelines Q8 [27]. The development of such techniques are intended to improve the manufacturing, development and quality assurance, as well as the overall cost-effectiveness, by implementing more robust manufacturing that reflects the understanding and science behind these processes. Better process monitoring and control would minimize loss of product and failed batches while improving overall product quality. PATs that have been explored for on-line, real-time process monitoring and control for fluidized bed coating of pellets include NIR [28], NIR in combination with Raman spectroscopy [29] and passive acoustic emissions monitoring [30].

The following review highlights common techniques employed for evaluating fluidization regimes and film coat properties, as well as the more advanced monitoring methods under development for pharmaceutical pellet coating in a fluidized bed.

## 2.2 Methods for Monitoring Fluidization Regimes

During fluidized bed coating it is important to maintain a balance between the break-up and cohesive forces provided by the fluidizing air and atomized liquid spray, respectively. The formation of agglomerates due to excessive moisture content may result

in local or complete defluidization, potentially ruining an entire batch. The main focus of monitoring fluidization regimes is to ensure a stable bubbling fluidization regime, allowing for good heat and mass transfer rates.

To identify fluidization regimes, visual observation has been used but is typically unreliable and highly subjective [31]. Another common method is the analysis of bed pressure fluctuation measurements. A more detailed review, provided by Silva et al. [31], discusses the methods used for monitoring fluidization regimes in both fluidized bed coating and granulation processes, where granulation is defined as the agglomeration of particulates to form larger granules. Research is limited regarding monitoring methods of fluidization regimes during fluidized bed coating in comparison to fluidized bed granulation.

### 2.2.1 Pressure Fluctuation Analysis

Pressure fluctuation signals can be analyzed in the time domain (standard deviation) or frequency domain (spectral analysis) by linear time series analysis, or in the state-space domain (chaos theory) by non-linear time series analysis [32]. Spectral analysis has been the focus of many studies, providing important information regarding fluidization regimes [31]. Specific to fluid bed coating processes, Parise et al. [4] was able to identify defluidization regions using the Gaussian spectral pressure distribution: a specific method of pressure fluctuation signal analysis [4]. A variety of coating experiments were performed with varying process conditions to monitor different fluidization regimes. For all experiments, the initial moment when defluidization began was identified. Further work included the improvement of fluid-dynamic conditions by developing a PI controller [5].

For monitoring fluidization regimes, pressure fluctuation analysis is often useful, but does not provide any information regarding specific properties of the film coat. As well, equipment modifications are required and additional regulations must be considered due to the possibility of bed material contacting the probe end. Ideally, an integrated control method capable of monitoring both fluidization and film coat parameters is desired.

## 2.3 Methods for Evaluating the Coating of Pharmaceutical Pellets

### 2.3.1 Traditional Methods

Conventional techniques employed to evaluate the film coat require sample acquisition for the theoretical determination of film thickness based on coating mass, and for dissolution and/or disintegration testing [6]. Such methods are invasive and disruptive to the process, and require laborious and inefficient off-line testing. These techniques have limited applicability to pellet coating due to the difference in size between pellets and tablets, and the difficulty associated with detecting small differences in weight. As well, a variety of assumptions are required to use these techniques: (i) the pellet and film coat are perfectly spherical, (ii) the film coat is uniform and equal, and (iii) all pellets are initially the same size [25]. Such traditional methods do not take into account any intra- or inter-pellet and film coat variations, as well as any loss of the film coat or pellet core due to attrition, leading to inaccurate estimations of film coat thickness and quality.

### 2.3.2 Image Analysis Methods

A variety of image analysis methods have been studied to characterize properties of the film coat. Such analytical tools are limited by the need to periodically remove samples from the coating process. Conventional image analyses, such as scanning electron microscopy (SEM) and fluorescence microscopy, are restricted to the particle surface, limiting a full analysis of the film coat [25]. Other methods require slicing of the pellet into segments, presenting a variety of problems including complete destruction of the pellet. These techniques are typically non-ideal for implementation in large-scale industrial processes. However, the methods presented below have led to important discoveries regarding fluidized bed coating, which may be applied to the development of future monitoring methods.

#### 2.3.2.1 Fluorescence Microscopy

Conventional fluorescence microscopy is often limited to the pellet surface, providing an indirect indication of film coat quality [25]. To better assess film coat thickness, Andersson et al. [23] developed an alternative method using fluorescence microscopy as

an image analysis technique. The method required that pellets be sliced into two equal parts, allowing for the film coat thickness to be determined by a difference in fluorescence intensity between the pellet core and coat. Pellet images were related to the release rate using mathematical models for the prediction of release rate variations. A major conclusion from the study identified significant variations in coat thickness resulting from inter- and intra- particle differences [23]. As well, the results touched on the applicability of using such imaging methods in combination with other techniques; for example, as a reference method for NIR spectra calibration.

A major disadvantage of the proposed method was the extensive sample preparation required for film coat analysis. Each sample removed from the process was carefully glued onto an iron plate and cut into two equal parts. The need for in-process sample acquisition and off-line sample preparation provided a non-ideal method for evaluating the film coat, especially for implementation in large-scale manufacture.

#### 2.3.2.2 Digital Imaging

Mozina et al. [6] investigated digital visual imaging for the assessment of pellet coating and particle agglomeration in a fluidized bed during a coating process. The method required that pellets be obtained from a manual sampler, located at the side of a fluidized bed. A variety of factors were concluded to negatively affect the digital visual measurements of pellet size and shape including variation in pellets, batch inhomogeneity, light background inhomogeneity, sensor noise, and incorrect system calibration [6]. Such factors influenced result accuracy, highlighting the need to minimize the impact of these variables on image processing techniques. The influence of agglomeration was identified to bias coat thickness values; agglomeration resulted in an increase in the average particle size, similar to the growth of the film coat [6].

Overall, the study showed that digital visual imaging was useful for evaluating pellet coating processes, regarding accuracy, precision, stability and speed [6]. The proposed method provided real-time, continuous measurements for the detection of agglomeration but was unable to provide an indication of the overall film coat quality. Drawbacks associated with the method included the influence of numerous factors on digital imaging

measurements, calibration of system parameters and the dependency on in-process sampling, which is disruptive to the process.

### 2.3.2.3 Confocal Laser Scanning Microscopy

Confocal laser scanning microscopy (CLSM) is defined as a non-destructive imaging technique, capable of characterizing the film coat through optical sectioning [25]. With the addition of fluorescent labeling, the film coat and core can be distinguished from one another [9,19,33]. Several studies have identified CLSM as a promising and convenient method for evaluating the film coat surface or average coat thickness of microcapsules [34-38]. Due to similarities in size, this suggests the promise of CLSM for evaluating the film coat of pharmaceutical pellets, in addition to microcapsules.

A quantitative image analysis method using CLSM in combination with a MATLAB image processor was developed by Laksmana et al. [24] to measure the film coat thickness and film coat pore size distribution of pharmaceutical pellets. The main purpose of this research was to analyze the film coat in terms of its functionality, providing important information regarding porosity and pore size distribution of the film coat. Coated pellets were compared from two fluidized bed configurations: top spray and bottom spray, where more porous pellets with larger pore sizes were concluded to be produced in top spray fluidized beds [24].

Depypere et al. [25] evaluated film coat quality, in addition to film coat thickness, using CLSM in combination with image analysis. A coat thickness distribution was generated providing more information regarding properties of the film coat. The quality of the film coat, as defined by Depypere et al. [25], is the ratio of average coat thickness to the average standard deviation of coat thickness distributions. Various case studies were performed on different fluidized bed configurations, leading to the following conclusions: i) high coating levels corresponded to an increase in coat quality, and ii) an increase in the distance between the nozzle tip and powder bed decreased the average coat thickness and decreased coat quality [25]. Overall, CLSM was capable of sufficiently measuring film coat thickness and quality of spherical, inert particulates less than 5  $\mu\text{m}$  in size. A resolution limit to the technique was identified, as thin films ( $<1 \mu\text{m}$ ) were difficult to

characterize due to the decreased contrast between the fluorescently labeled film coat and pellet [25].

For both studies, the film coat thickness was calculated indirectly, potentially leading to inaccurate estimations. Invasive sampling, fluorescent labeling, off-line analysis and extensive image processing limit the industrial application of analytical methods involving CLSM.

#### 2.3.2.4 X-ray Micro Tomography

X-ray micro tomography is defined as a non-destructive imaging technique capable of providing two-dimensional (2D) and three-dimensional (3D) images [26]. The images are produced based on the way X-rays attenuate in different matter, which is influenced by the density and atomic number of the matter being studied [26]. The reconstruction of various cross sectional images using mathematical algorithms produces a 3D image of the object.

Perfetti et al. [26] examined the feasibility of X-ray micro tomography to evaluate numerous characteristics of film coat quality, including coat thickness, uniformity, porosity, density, volume and surface area. The method was able to non-destructively produce high-resolution 3-D images, providing an in-depth analysis of the film coat. It was concluded that spherical particles corresponded to a smoother coating surface compared to coated non-spherical particles. Overall, X-ray micro tomography was identified as advantageous over SEM due to its higher statistical reliability and non-destructive imaging technique [26].

X-ray micro tomography requires complex mathematical algorithms in order to reconstruct images, as well as expensive X-ray equipment and technology [26]. The resolution of the technique is limited due to difficulty in distinguishing between the film coat and pellet core when a thin layer of coating is applied. Again, in-process sampling presents a potential disruption to the process. The methods dependency on material density and atomic number limits the quality of the image. X-ray micro tomography is a powerful tool for characterizing the film coat, providing specific details and high quality

information, but the limited resolution and inability to provide rapid at-line information restrict its current applicability for daily process control.

### 2.3.3 Spectroscopic Methods

#### 2.3.3.1 Raman Spectroscopy

Optical spectroscopy is an analytical technique based on the absorbance of frequencies at different wavelengths, ranging from the ultraviolet and visible region to the infrared region, where Raman spectra are identified as comparable to infrared spectra [29]. Raman spectroscopy was assessed by Sovany et al. [39] to evaluate film coat thickness compared to traditional methods. Two problems were encountered during this study: i) the intensity of the Raman signal weakened as a result of scattered light and the difference in size between the pellet and large laser spot, and ii) characteristic peaks of the active pharmaceutical ingredient overlapped with peaks of the coating material leading to inconclusive results. The study confirmed general issues experienced with Raman spectroscopy, where a weak signal is easily influenced by background effects corresponding to difficult analyses [29]. Implementing additional scans and selecting appropriate measurement conditions have the potential to minimize these issues [39].

#### 2.3.4 Evaluating Colour

When evaluating film coat uniformity, colour distribution can be measured to provide an indication of film coat properties. Traditionally a tristimulus colorimeter is used, which measures colour by rotating the pellet on a stage with a sharp pair of forceps [40]. The pellet often favors a side as it rotates, influencing the accuracy of the results. To improve this technique, Chan et al. [40] analyzed four methods for measuring the color distribution of coated pellets, including the use of a specially designed pellet holder. The new pellet holder improved the measurement of pellet color homogeneity but was associated with some significant disadvantages, including time-consuming sample acquisition and again, off-line testing.



## 2.4 Methods for Monitoring the Coating of Pharmaceutical Pellets

The discussed methods for evaluating coated pharmaceutical pellets are associated with various drawbacks, including the practice of in-process sampling followed by extensive off-line testing. This leads to disruptive, time-consuming and inaccurate analyses, indicating the need for developing non-invasive tools that provide on-line and real-time measurements for process monitoring and control. Spectroscopic and acoustic methods, as well as visiometric process analyzers, have been explored as potential tools to monitor fluidized bed coating processes.

### 2.4.1 Spectroscopic Methods

#### 2.4.1.1 Near Infrared Spectroscopy

As an analytical tool, near-infrared (NIR) spectroscopy has been gaining popularity in the pharmaceutical industry due to its ability and potential to provide fast, easy, sensitive, non-invasive and non-destructive analysis [41]. It is often used to determine the moisture content of pharmaceutical materials and/or products during pharmaceutical production [29]. A more detailed review provided by Roggo et al. [10] summarizes applications of NIR spectroscopy in the pharmaceutical industry. There are limited studies that focus on the application of NIR spectroscopy for the analysis of coated pharmaceutical pellets in a fluidized bed.

One study conducted by Lee et al. [28] combined NIR spectroscopy with CLSM and particle size analysis (LD-PSA) to develop calibration models for the assessment of film coat thickness and for the prediction of an optimal coating process end-point. Both models resulted in good correlations, despite larger thickness values recorded for LD-PSA compared to CLSM. A consistent change in the coat thickness was suggested to explain why both produced good calibration models. The developed models were able to predict the coating thickness in separate experiments with 99% accuracy [28].

A significant disadvantage of using NIR spectroscopy was the extensive calibration of spectra and the corresponding complex analysis required. The invasive nature of the fiber

optic probe, in this case, to obtain NIR data and periodic sampling needed for CLSM and LD-PSA analyses were major drawbacks of the method. A window or port into the vessel and other equipment modifications are often required when using spectroscopic methods.

Kato et al. [41] evaluated the risks and benefits of using NIR spectroscopy for process monitoring. The study found different coating formulations, variations in coating thickness and amount of coating applied influenced the accuracy of NIR spectra [41]. Specifically, NIR spectroscopy was evaluated on its ability to determine the coating process end-point for spherical and cylindrical pharmaceutical pellets. Spherical granules, where the coating layer was characteristically thin, provided good results for NIR spectroscopy [41]. On the contrary, cylindrical granules, where the coating layer was much thicker, resulted in the misinterpretation of data. As the layer increased, the titanium dioxide in the coating layer caused the NIR light to scatter, indicating false saturation [41]. The study emphasized the influence of film coat parameters and pellet shape on the chosen monitoring method and its corresponding accuracy.

#### 2.4.1.2 Near Infrared in Combination with Raman Spectroscopy

Bogomolov et al. [29] studied the combination of NIR and Raman spectroscopy for monitoring the coating of pellets in a fluidized bed. Four batch experiments were analyzed to assess measurement sensitivity to coat thickness and moisture content. Wet pellets were concluded to influence light propagation, where a high level of moisture content corresponded to lower spectra intensity due to an increase in incident light penetrating the coating material [29]. Over wet process conditions were found to interfere with the spectroscopic measurements, affecting spectra intensity. It was concluded that the acquired spectra provided some important information related to the process, overall presenting a potential monitoring method.

Drawbacks of the monitoring method included the extensive calibration and analysis required; a common issue with spectroscopic methods. The probe used to acquire spectra data was placed within the fluidized bed resulting in potential probe fouling and contamination issues, affecting measurement accuracy. Additionally, manual operation

was needed to collect Raman spectra, which is time-consuming and inefficient for large scale process monitoring.

#### 2.4.2 Passive Acoustic Emissions

Passive acoustic emissions have been explored as a monitoring technique in various industries, such as the chemical, biochemical and food industries, to provide insight into physicochemical changes that occur within a process [42]. Acoustics, defined as the generation, transmission and reception of energy in the form of vibrational waves [43], have the ability to collect process information non-invasively, providing on-line and real-time measurements. In the pharmaceutical industry passive acoustic emissions have been used to monitor high-shear and fluidized bed granulation processes, as well as fluidized bed drying and mixing processes [44-50]. In a fluidized bed, the passive acoustic emissions are generated as a result of (i) particle-particle or particle-equipment collisions, (ii) friction resulting from these collisions, and (iii) air turbulence from the fluidizing air [44], and measured by microphones attached externally to the unit. There is limited research focusing on the application of passive acoustic emissions monitoring for the coating of pharmaceutical pellets in a fluidized bed.

One study, conducted by Naelapää et al. [30], identified passive acoustic emissions as a potential method for monitoring the coating of pharmaceutical pellets in a fluidized bed. Vibrations from the passive acoustic emissions produced during the coating of potassium chloride crystals were measured using four accelerometers. The acquired signals were compared to the estimated coat thickness by dissolution testing and the theoretical amount of film coating applied. The monitoring technique showed promise but produced inconclusive results due to: (i) repositioning of sensors between batches resulting in signal differences, (ii) limited samples were removed providing an unrepresentative sample of the entire batch and (iii) an indirect estimate of the film coating was measured using the volume drop of the coating solution rather than directly measuring the actual coating on the pellets. Naelapää et al. concluded that additional research, proper sampling procedures and improved product characterization was necessary to confirm the use of passive acoustic emissions as a method for process monitoring and control [30].

### 2.4.3 Visiometric Process Analyzers

A main source of variability during the coating process is a result of the circulation pattern of particles within a fluidized bed, influencing coat uniformity. Liew et al. [51] proposed the use of high-speed imaging to track particle recirculation in a partition column of a bottom spray fluidized bed. High-speed imaging combined with ensemble correlation particle image velocimetry allowed for the quantification of particle recirculation within a fluidized bed [51]. According to Liew et al. [51], the integration of visiometric process analyzers with other process analyzers has the potential to increase process understanding and provide a more complete approach to process control.

A supplementary study focused on applying visiometric process analyzers to monitor particle mass flow rate. More specifically, the effect of the partition gap and air accelerator insert size on the downward movement of particles in a bottom spray fluidized bed was assessed [52]. The results of the study concluded that a higher partition gap corresponded to an increase in mass flow rate, increasing particle circulation within the column, resulting in a more uniform coating layer.

The proposed monitoring method is non-invasive and sensitive to process changes, with the ability to provide real-time measurements. On the contrary, a transparent unit, observation window or clear partition column is required, which is uncommon for large-scale coating processes. For large-scale implementation, additional modifications would be required, such as an increase in the intensity of the laser light and the development of correction factors for distorted images due to the increase in column size [52]. At a larger scale, a significant amount of data would be generated, increasing the amount of data to be processed. The developed method has only been applied to bottom spray fluidized beds, as the uniformity of the coating layer was related to pellet movement within a partition column, and is therefore, not applicable to top or tangential spray fluidized beds.

## 2.5 Conclusions

The process of fluidized bed coating involves the complex interaction between gas, liquid and solid phases, and is easily influenced by variations in process parameters. For the manufacture of a desired end-product the process must be carefully monitored and

controlled regarding fluidization regimes and properties of the film coat. Pressure fluctuation signal analysis is the most common method employed to monitor fluidization regimes providing an indication of the onset of defluidization, but the method still requires equipment modifications and is associated with the potential for probe fouling. A variety of evaluation techniques have been explored to analyze properties of the film coat, but are often associated with in-process sampling and inefficient off-line analyses. Due to the preferred implementation of process analytical technologies for the improvement of pharmaceutical manufacturing, the development of non-invasive, on-line and real-time monitoring tools has been explored. Various techniques, including spectroscopic and acoustic methods, as well as visiometric process analyzers, are currently being studied for their monitoring potential. Passive acoustic emissions monitoring provide a non-invasive and affordable solution, requiring less extensive signal analysis compared to other techniques. For large-scale industrial implementation, additional research is still required. Ideally, a combination of analytical tools capable of monitoring and controlling both fluidization regimes and film coat properties is desired.

## 2.6 References

- [1] M. Hemati, R. Cherif, K. Saleh, V. Pont, Fluidized bed coating and granulation: influence of process-related variables and physicochemical properties on the growth kinetics, *Powder Technology*, 130 (2003) 18-34.
- [2] E. Teunou, D. Poncelet, Batch and continuous fluid bed coating – review and state of the art, *Journal of Food Engineering*, 53 (2002) 325-340.
- [3] J.F. Nunes, C.A.M. da Silva, S.C.S.R. Silva Moris, O.P. Taranto, Spectral analysis of pressure drop fluctuation in vibrofluidized bed coating, *Chemical Engineering Transactions*, (2011) 649-654.
- [4] M.R. Parise, C.A.M. Silva, M.J. Ramazini, O.P. Taranto, Identification of defluidization in fluidized bed coating using the Gaussian spectral pressure distribution, *Powder Technology*, 206 (2011) 149-153.

- [5] C.A.M. Silva, M.R. Parise, F.V. Silva, O.P. Taranto, Control of fluidized bed coating particles using Gaussian spectral pressure distribution, *Powder Technology*, 212 (2011) 445-458.
- [6] M. Možina, D. Tomažević, S. Leben, F. Pernuš, B. Likar, Digital imaging as a process analytical technology tool for fluid-bed pellet coating process, *European Journal of Pharmaceutical Sciences*, 41 (2010) 156-162.
- [7] B. Buchanan, M. Baxter, T.S. Chen, X.-Z. Qin, P. Robinson, Use of Near-Infrared Spectroscopy to Evaluate an Active in a Film Coated Tablet, *Pharmaceutical Research*, 13 (1996) 616-621.
- [8] J. Kirsch, J. Drennen, Near-Infrared Spectroscopic Monitoring of the Film Coating Process, *Pharmaceutical Research*, 13 (1996) 234-237.
- [9] M. Andersson, M. Josefson, F.W. Langkilde, K.G. Wahlund, Monitoring of a film coating process for tablets using near infrared reflectance spectrometry, *Journal of Pharmaceutical and Biomedical Analysis*, 20 (1999) 27-37.
- [10] Y. Roggo, P. Chalus, L. Maurer, C. Lema-Martinez, A. Edmond, N. Jent, A review of near infrared spectroscopy and chemometrics in pharmaceutical technologies, *Journal of Pharmaceutical and Biomedical Analysis*, 44 (2007) 683-700.
- [11] J.J. Moes, M.M. Ruijken, E. Gout, H.W. Frijlink, M.I. Ugwoke, Application of process analytical technology in tablet process development using NIR spectroscopy: Blend uniformity, content uniformity and coating thickness measurements, *International Journal of Pharmaceutics*, 357 (2008) 108-118.
- [12] A.J. Fitzgerald, B.E. Cole, P.F. Taday, Nondestructive analysis of tablet coating thicknesses using terahertz pulsed imaging, *Journal of Pharmaceutical Sciences*, 94 (2005) 177-183.
- [13] J.A. Zeitler, Y. Shen, C. Baker, P.F. Taday, M. Pepper, T. Rades, Analysis of coating structures and interfaces in solid oral dosage forms by three dimensional terahertz pulsed imaging, *Journal of Pharmaceutical Sciences*, 96 (2007) 330-340.

- [14] L. Ho, R. Müller, M. Römer, K.C. Gordon, J. Heinämäki, P. Kleinebudde, M. Pepper, T. Rades, Y.C. Shen, C.J. Strachan, P.F. Taday, J.A. Zeitler, Analysis of sustained-release tablet film coats using terahertz pulsed imaging, *Journal of Controlled Release*, 119 (2007) 253-261.
- [15] L. Maurer, H. Leuenberger, Terahertz pulsed imaging and near infrared imaging to monitor the coating process of pharmaceutical tablets, *International Journal of Pharmaceutics*, 370 (2009) 8-16.
- [16] S. Romero-Torres, J.D. Pérez-Ramos, K.R. Morris, E.R. Grant, Raman spectroscopy for tablet coating thickness quantification and coating characterization in the presence of strong fluorescent interference, *Journal of Pharmaceutical and Biomedical Analysis*, 41 (2006) 811-819.
- [17] A. El Hagrasy, S.-Y. Chang, D. Desai, S. Kiang, Raman spectroscopy for the determination of coating uniformity of tablets: assessment of product quality and coating pan mixing efficiency during scale-up, *Journal of Pharmaceutical Innovation*, 1 (2006) 37-42.
- [18] J. Müller, K. Knop, J. Thies, C. Uerpmann, P. Kleinebudde, Feasibility of Raman spectroscopy as PAT tool in active coating, *Drug Development and Industrial Pharmacy*, 36 (2010) 234-243.
- [19] M. Ruotsalainen, J. Heinämäki, H. Guo, N. Laitinen, J. Yliruusi, A novel technique for imaging film coating defects in the film-core interface and surface of coated tablets, *European Journal of Pharmaceutics and Biopharmaceutics*, 56 (2003) 381-388.
- [20] M.D. Mowery, R. Sing, J. Kirsch, A. Razaghi, S. Béchard, R.A. Reed, Rapid at-line analysis of coating thickness and uniformity on tablets using laser induced breakdown spectroscopy, *Journal of Pharmaceutical and Biomedical Analysis*, 28 (2002) 935-943.
- [21] M.C. Madamba, W. Mullett, S. Debnath, E. Kwong, Characterization of tablet film coatings using a laser-induced breakdown spectroscopic technique, *AAPS PharmSciTech*, 8 (2007) 184-190.

- [22] G. Reich, Potential of attenuated total reflection infrared and near-infrared spectroscopic imaging for quality assurance/quality control of solid pharmaceutical dosage forms, *Pharmazeutische Industrie*, 64 (2002) 870-874.
- [23] M. Andersson, B. Holmquist, J. Lindquist, O. Nilsson, K.-G. Wahlund, Analysis of film coating thickness and surface area of pharmaceutical pellets using fluorescence microscopy and image analysis, *Journal of Pharmaceutical and Biomedical Analysis*, 22 (2000) 325-339.
- [24] F.L. Laksmna, L.J. Van Vliet, P.J.A. Hartman Kok, H. Vromans, H.W. Frijlink, K. Van der Voort Maarschalk, Quantitative Image Analysis for Evaluating the Coating Thickness and Pore Distribution in Coated Small Particles, *Pharmaceutical Research*, 26 (2009) 965-976.
- [25] F. Depypere, P. Van Oostveldt, J.G. Pieters, K. Dewettinck, Quantification of microparticle coating quality by confocal laser scanning microscopy (CLSM), *European Journal of Pharmaceutics and Biopharmaceutics*, 73 (2009) 179-186.
- [26] G. Perfetti, E.V.d. Castele, B. Rieger, W.J. Wildeboer, G.M.H. Meesters, X-ray micro tomography and image analysis as complementary methods for morphological characterization and coating thickness measurement of coated particles, *Advanced Powder Technology*, 21 (2010) 663-675.
- [27] Food and Drug Administration, Guidance for Industry: PAT a framework for innovative pharmaceutical development, manufacturing and quality assurance, DHHS, Rockville, MD, 2004.
- [28] M.-J. Lee, D.-Y. Seo, H.-E. Lee, I.-C. Wang, W.-S. Kim, M.-Y. Jeong, G.J. Choi, In line NIR quantification of film thickness on pharmaceutical pellets during a fluid bed coating process, *International Journal of Pharmaceutics*, 403 (2011) 66-72.
- [29] A. Bogomolov, M. Engler, M. Melichar, A. Wigmore, In-line analysis of a fluid bed pellet coating process using a combination of near infrared and Raman spectroscopy, *Journal of Chemometrics*, 24 (2010) 544-557.



- [30] K. Naelapää, P. Veski, J.G. Pedersen, D. Anov, P. Jørgensen, H.G. Kristensen, P. Bertelsen, Acoustic monitoring of a fluidized bed coating process, *International Journal of Pharmaceutics*, 332 (2007) 90-97.
- [31] C.A.M. da Silva, J.J. Butzge, M. Nitz, O.P. Taranto, Monitoring and control of coating and granulation processes in fluidized beds – A review, *Advanced Powder Technology*, 25 (2014) 195-210.
- [32] F. Johnsson, R.C. Zijerveld, J.C. Schouten, C.M. van den Bleek, B. Leckner, Characterization of fluidization regimes by time-series analysis of pressure fluctuations, *International Journal of Multiphase Flow*, 26 (2000) 663-715.
- [33] A. Lamprecht, U. Schafer, C.M. Lehr, Structural analysis of microparticles by confocal laser scanning microscopy, *AAPS PharmSciTech*, 1 (2000) E17.
- [34] G.M.R. Vandenbossche, P. Van Oostveldt, J.P. Remon, A fluorescence method for the determination of the molecular weight cut-off of alginate-polylysine microcapsules, *Journal of Pharmacy and Pharmacology*, 43 (1991) 275-277.
- [35] A. Lamprecht, U.F. Schafer, C. Lehr, Characterization of microcapsules by confocal laser scanning microscopy: structure, capsule wall composition and encapsulation rate, *Eur J Pharm Biopharm*, Netherlands, 2000, pp. 1-9.
- [36] A. Lamprecht, U.F. Schafer, C.M. Lehr, Visualization and quantification of polymer distribution in microcapsules by confocal laser scanning microscopy (CLSM), *Int J Pharm*, Netherlands, 2000, pp. 223-226.
- [37] H. Zimmermann, M. Hillgärtner, B. Manz, P. Feilen, F. Brunnenmeier, U. Leinfelder, M. Weber, H. Cramer, S. Schneider, C. Hendrich, F. Volke, U. Zimmermann, Fabrication of homogeneously cross-linked, functional alginate microcapsules validated by NMR-, CLSM- and AFM-imaging, *Biomaterials*, 24 (2003) 2083-2096.
- [38] B.L. Strand, Y.A. Mørch, T. Espevik, G. Skjåk-Bræk, Visualization of alginate–poly-L-lysine–alginate microcapsules by confocal laser scanning microscopy, *Biotechnology and Bioengineering*, 82 (2003) 386-394.

- [39] T. Sovány, K. Nikowitz, G. Regdon Jr, P. Kása Jr, K. Pintye-Hódi, Raman spectroscopic investigation of film thickness, *Polymer Testing*, 28 (2009) 770-772.
- [40] L.W. Chan, W.Y. Chan, P.W.S. Heng, An improved method for the measurement of colour uniformity in pellet coating, *International Journal of Pharmaceutics*, 213 (2001) 63-74.
- [41] Y. Kato, D. Sasakura, T. Miura, A. Nagatomo, K. Terada, Evaluation of Risk and Benefit in the Application of Near-Infrared Spectroscopy to Monitor the Granule Coating Process, *Pharmaceutical Development and Technology*, 13 (2008) 205-211.
- [42] J. W.R. Boyd, J. Varley, The uses of passive measurement of acoustic emissions from chemical engineering processes, *Chemical Engineering Science*, 56 (2001) 1749-1767.
- [43] L.E. Kinsler, A.R. Frey, A.B. Coppens, J.V. Sanders, *Fundamentals of Acoustics*, Wiley-VCH1999.
- [44] H. Tsujimoto, T. Yokoyama, C.C. Huang, I. Sekiguchi, Monitoring particle fluidization in a fluidized bed granulator with an acoustic emission sensor, *Powder Technology*, 113 (2000) 88-96.
- [45] L. Briens, D. Daniher, A. Tallevi, Monitoring high-shear granulation using sound and vibration measurements, *International Journal of Pharmaceutics*, 331 (2007) 54-60.
- [46] E.M. Hansuld, L. Briens, J.A.B. McCann, A. Sayani, Audible acoustics in high-shear wet granulation: Application of frequency filtering, *International Journal of Pharmaceutics*, 378 (2009) 37-44.
- [47] E.M. Hansuld, L. Briens, A. Sayani, J.A.B. McCann, An investigation of the relationship between acoustic emissions and particle size, *Powder Technology*, 219 (2012) 111-117.
- [48] S. Matero, S. Poutiainen, J. Leskinen, K. Järvinen, J. Ketolainen, S.P. Reinikainen, M. Hakulinen, R. Lappalainen, A. Poso, The feasibility of using acoustic emissions for

monitoring of fluidized bed granulation, *Chemometrics and Intelligent Laboratory Systems*, 97 (2009) 75-81.

[49] D. Vervloet, J. Nijenhuis, J.R. van Ommen, Monitoring a lab-scale fluidized bed dryer: A comparison between pressure transducers, passive acoustic emissions and vibration measurements, *Powder Technology*, 197 (2010) 36-48.

[50] P. Allan, L.J. Bellamy, A. Nordon, D. Littlejohn, Non-invasive monitoring of the mixing of pharmaceutical powders by broadband acoustic emission, *The Analyst*, 135 (2010) 518-524.

[51] C.V. Liew, L.K. Wang, P. Wan Sia Heng, Development of a visiometric process analyzer for real-time monitoring of bottom spray fluid-bed coating, *Journal of Pharmaceutical Sciences*, 99 (2010) 346-356.

[52] L.K. Wang, P.W.S. Heng, C.V. Liew, Online monitoring of particle mass flow rate in bottom spray fluid bed coating—Development and application, *International Journal of Pharmaceutics*, 395 (2010) 215-221.

## Chapter 3

### 3 Passive Acoustic Emissions Monitoring of the Coating of Pellets in a Fluidized Bed – A Feasibility Analysis

#### 3.1 Introduction

Pharmaceutical pellets are small, spherical particles between 100 and 1000  $\mu\text{m}$  in diameter that contain the active ingredient or drug. These pellets are film coated to control the release rate of the active ingredient, as well as to protect the drug from heat, moisture and light, provide mechanical stability and improve appearance of the dosage form [1]. The coated pellets are packed into capsules to create a multiple unit dosage form to be taken orally. The release rate of the active drug is dependent on the uniformity, thickness and overall quality of the coating film on the pellets [2-4]. Capsules containing coated pellets are a relatively new multiple unit dosage form. This form has advantages over conventional tablets of reducing variations in gastro intestinal transit time and minimizing the potential of dosage dumping [5], which are significant factors for potent drugs with critical dosages and delivery.

Coating processes are performed in either a rotated drum pan coater or a fluidized bed coater of the top spray, bottom spray or rotating configuration. For larger solid dosage forms such as tablets pan coating is preferred [6], while fluidized bed coating is better suited for the lighter, smaller dosage forms such as pellets. These particles are easier to fluidize resulting in good particle mixing. An atomized liquid spray consisting of a solute and solvent is sprayed onto the fluidized pellet bed. The heated fluidizing air evaporates the solvent, leaving behind the solute to form the coating film around the pellet core [1].

Fluidized bed coating is a complex process. A variety of parameters must be taken into consideration to ensure the desired end-product is achieved, including the inlet/outlet temperature, inlet/outlet humidity, superficial gas velocity, atomizing air pressure, spray rate and droplet size [7]. Due to the interdependence of these parameters, an on-line and real-time monitoring technique is required to provide further insight into process dynamics and to improve process control. A top spray fluidized bed has exceptional need

for the development of process monitoring and control, as these coating processes are associated with random particle flow, non-uniform coating and a high risk of bed defluidization [1,8,9].

Pressure measurement analysis is the most common technique for monitoring fluidization. These measurements have been used to detect bed defluidization, evaluate regime transitions and to provide insight into fluidization phenomena [10-12]. Pressure fluctuation analysis may provide general information about fluidization behavior of fluidized bed coating, but provides no information about the film coat.

Conventional techniques used to evaluate the film coat of tablets require sample acquisition for the theoretical determination of film thickness based on coating mass and for dissolution or disintegration testing [13]. These techniques have many drawbacks especially for pellet coating: (i) the weight gains of the pellets are small and difficult to accurately measure, (ii) variations between pellets are not considered, (iii) measurement of weight gain does not account for any loss of the core pellet due to attrition, (iv) disintegration and/or dissolution testing provides only an indirect measurement of coat thickness and does not evaluate coat uniformity, and (v) sampling and measurements are time consuming and therefore cannot provide real time information that is critical for process control. Techniques that are being developed to improve measurement of coating include a variety of imaging and spectroscopic methods [2,3,14,15]. These methods, however, still involve in-process sampling and off-line testing, which are disruptive to the process, time-consuming and inaccurate.

Research has shifted towards the development of on-line, non-invasive monitoring tools for process control, due to the Food and Drug Administration's initiative to implement process analytical technologies (PATs) for the improvement of pharmaceutical manufacturing, development and quality assurance [16].

Techniques that have been investigated for on-line and real-time monitoring and control of fluidized bed coating of pellets include near infrared spectroscopy [4], combined near infrared and Raman spectroscopy [17] and passive acoustic emissions monitoring [9].

Raman and near infrared spectroscopy both require a window or port into the process

vessel which necessitates equipment modifications and can also lead to inaccurate measurements if the window or probe interface becomes fouled. In addition, Bogomolov et al. [17] found that over wet process conditions interfered with the measurements, as the wet pellets changed light propagation conditions, which affect the intensity of the spectra. Depypere et al. [2] further argued that near infrared spectroscopy does not have the required spatial resolution to enable accurate measurements of the pellet coating as the pellets themselves are small and the coating is thin, about 25 to 75  $\mu\text{m}$ .

Acoustics, defined as the generation, transmission and reception of energy in the form of vibrational waves [18], have shown potential as a basis for the development of on-line monitoring and control systems. As a monitoring technique, it has been explored in various industries, such as the chemical, biochemical and food industries, to provide insight into the physicochemical changes that occur within a process [19]. Specifically, in the pharmaceutical industry, passive acoustic emissions have been used to monitor high-shear and fluidized bed granulation processes, as well as fluidized bed drying [20-25]. A major advantage of acoustic emissions monitoring is the non-invasive nature and real-time means of collecting process information.

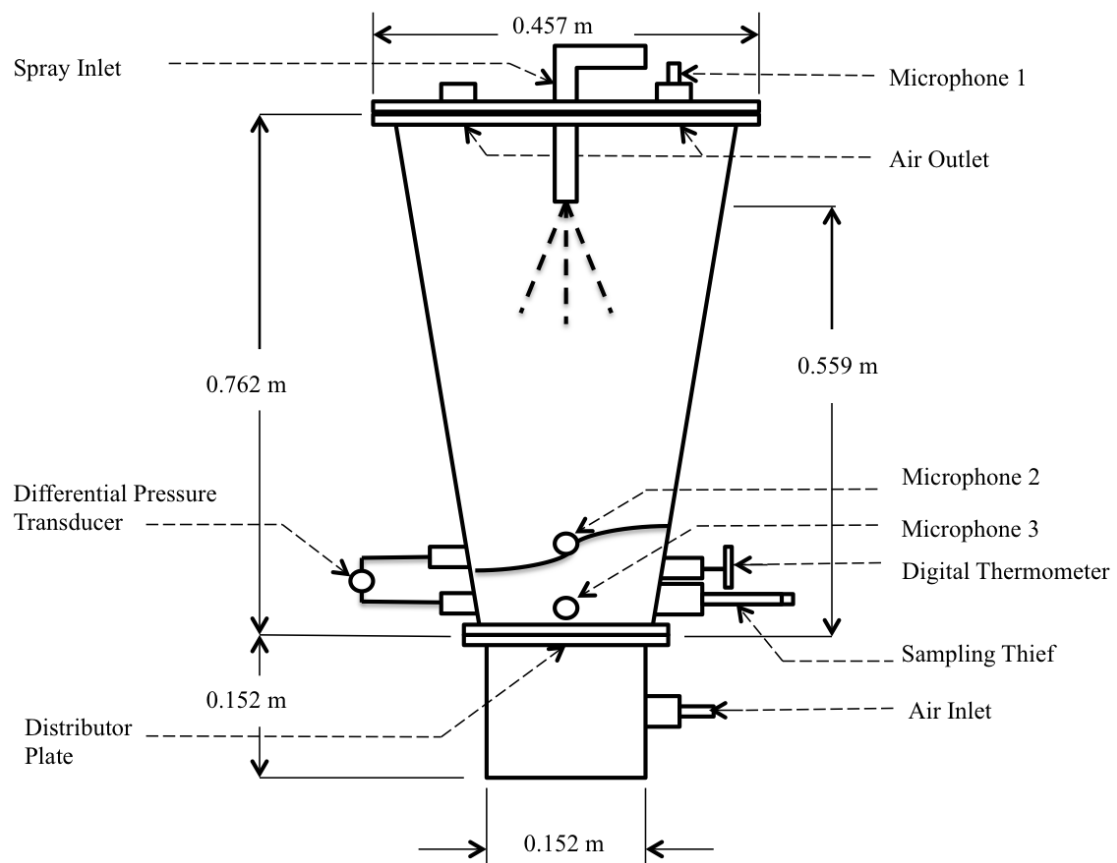
Passive acoustic emissions from a fluidized bed, described by Tsujimoto et al. [20], are generated as a result of (i) particle-particle or particle-equipment collisions, (ii) friction from these collisions, and (iii) air turbulence generated by the fluidizing air passing through the particle bed. One study, conducted by Naelapää et al. [9], highlighted the possibility of applying passive acoustic emissions monitoring for the coating of pellets in a fluidized bed. Four accelerometers were used to measure the vibrations from the passive acoustic emissions during the coating of potassium chloride crystals and the signals were compared to samples tested for dissolution and to the theoretical amount of film applied. The technique appeared promising, but many of their results were inconclusive due to: (i) differences in the signals from repositioning the sensors between batches, (ii) samples were not representative of the entire batch as only limited samples were extracted and (iii) the amount of applied coating was estimated from the volume drop in coating solution rather than direct measurements of the actual coated pellets.

Our research builds from the work by Naelapää et al. [9] carefully considering the factors that led to their inconclusive results. Due to limited research on the development of monitoring methods for fluidized bed coating of pharmaceutical pellets, the objective of our research was to assess the possibility of applying passive acoustic emissions monitoring to the coating of pellets in a fluidized bed.

## 3.2 Materials and Methods

### 3.2.1 Fluidized Bed

A schematic of the top spray fluidized bed is shown in Figure 3-1. The air entered a wind box and is then distributed into the conical bed through a polyethylene distributor plate with a pore size of  $75\ \mu\text{m}$ .



**Figure 3-1:** Schematic of top spray fluidized bed with instrumentation

A differential pressure transducer (Omega Model 163PC01D36) recorded pressure data using a National Instruments data acquisition system and LabVIEW software. The transducer measured the pressure drop across the bed (one port located 0.050 m above the grid and a second port located 0.100 m above the grid) at a sampling rate of 1000 Hz.

Three piezoelectric microphones (PCB Piezotronics Model 130P10) were used to record passive acoustic emissions. The data was recorded using a National Instruments data acquisition system and LabVIEW software. Microphone 1 was suspended in the exhaust of one of the air outlets located at the top of the column. Microphones 2 and 3 were attached flush to the exterior of the column 0.150 m and 0.025 m above the grid, respectively. This allowed for measurements to be obtained at the interface of the fluidized pellet bed and liquid spray, and at the grid. All three microphones recorded data at a sampling rate of 40 000 Hz to allow full reconstruction of the audible frequency range (20 – 20 000 Hz) without aliasing. Statistical and frequency signal analysis was performed off-line using Matlab version 7.10 in 10 second consecutive chunks.

A sampling port with a side sampling thief, located 0.057 m above the grid, allowed for samples to be withdrawn during trials. An atomizing spray nozzle (John Brooks Company Limited, Reference #: 1/8 PRJJB 0.0390) was located at the top of the column. The spray tip was 0.559 m above the distributor. The top of the column contained four filtered air outlets.

### 3.2.2 Coating Experiments

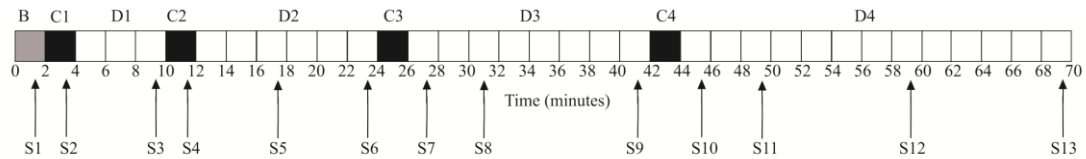
Glass pellets, 1000  $\mu\text{m}$  in diameter and a density of 2.4  $\text{g}/\text{cm}^3$ , were coated with a 5% (w/w) sugar solution. These materials were selected as a reusable, model pellet system comparable to microcrystalline cellulose starter cores, Cellets<sup>®</sup>, that have a diameter of 1000  $\mu\text{m}$  and a density of 0.8  $\text{g}/\text{cm}^3$ , and are often coated and used in multi-particulate dosage forms. For each trial approximately 2 kg of glass pellets were coated.

The inlet air temperature was heated to 35 °C with a humidity of approximately 15%. A superficial gas velocity of 1.85 m/s was used to fluidize the pellets. An atomizing spray



pressure of approximately 40 psi was used to spray the coating solution, corresponding to a spray rate of approximately 20 mL/min.

Coating was performed over four 2-minute intervals, with a total coating time of 8 minutes (Figure 3-2). Approximately 10.0 g of pellets were removed periodically using the sampling port during each trial. Samples were removed before and after each coating period (S1, S2, S3, S4, S6, S7, S9, S10) and throughout the drying period (S5, S8, S11, S12, S13). From each sample, 100 pellets were carefully counted, weighed, washed with 1000 mL of warm water at 35°C, dried on trays for about 20 hours at a temperature of 20°C and humidity of 10%, and re-weighed once dry. The coat thickness per pellet was calculated based on the coating mass per 100 pellets, assuming the film coat was perfectly uniform and evenly distributed among the 100 pellets. This allowed for the film coat thickness to be directly measured for each sample.



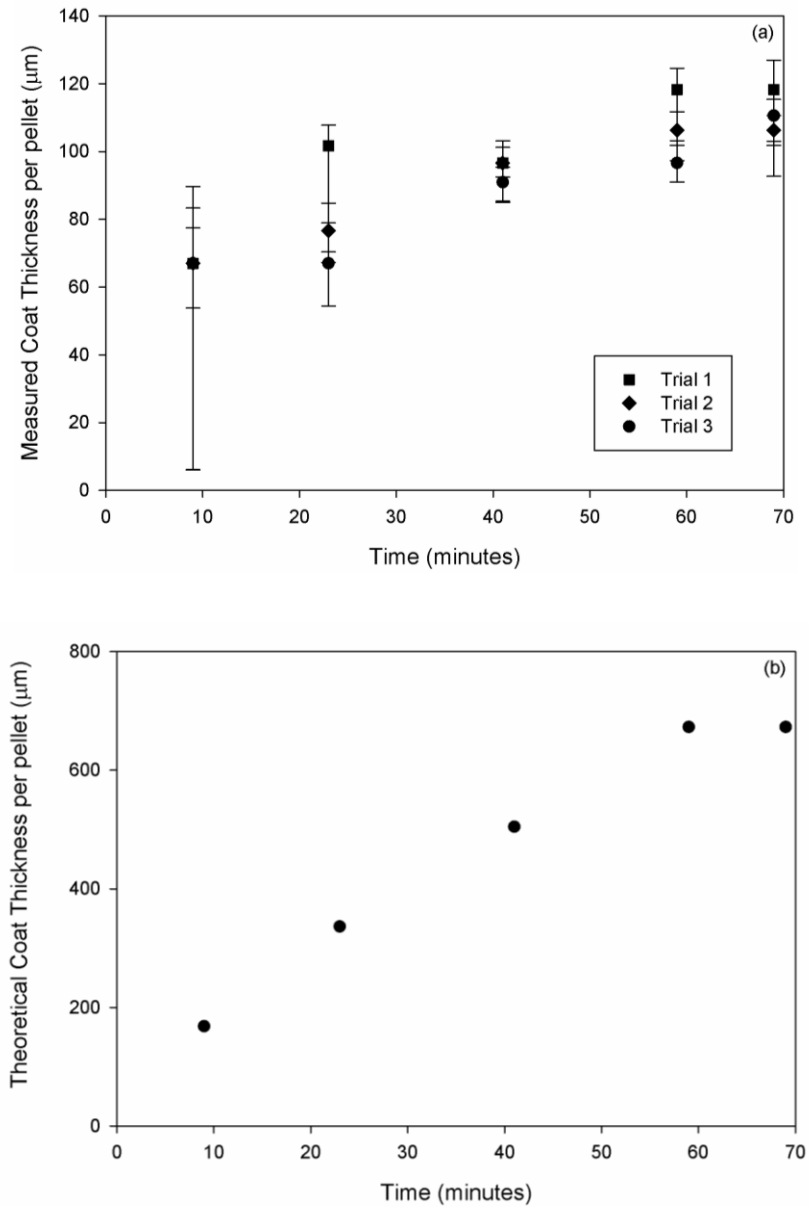
**Figure 3-2:** Coating timeline - B: Baseline, C: Coating Period, D: Drying Period, S: Sample

Acoustic and pressure measurements were recorded during each trial. The measurements were started prior to the first coating period to ensure measurements taken under initial stable operating conditions. Preliminary trials were conducted to assess the sampling and passive acoustic emission measurements. Consistent and reproducible results could be obtained. In addition, it was confirmed that samples could be removed from the bed at intervals without significantly affecting the bed dynamics.

### 3.3 Results

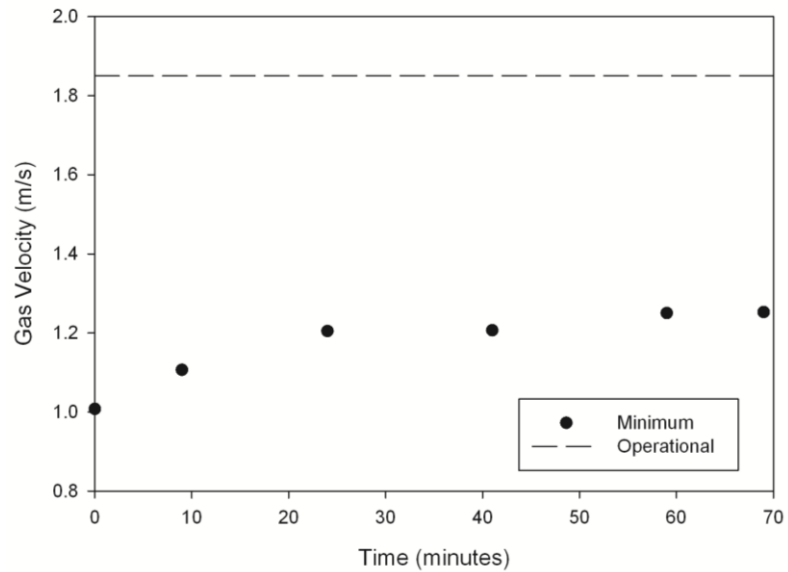
Coat thickness was expected to increase after each coating period. Figure 3-3a shows a slight increase in the measured coat thickness per pellet during each trial. The coat thickness from theoretical calculations, shown in Figure 3-3b, was calculated through

mass balances using the spray rate over the 2 minute coating interval and assuming perfect, uniform coating for every pellet within the bed.



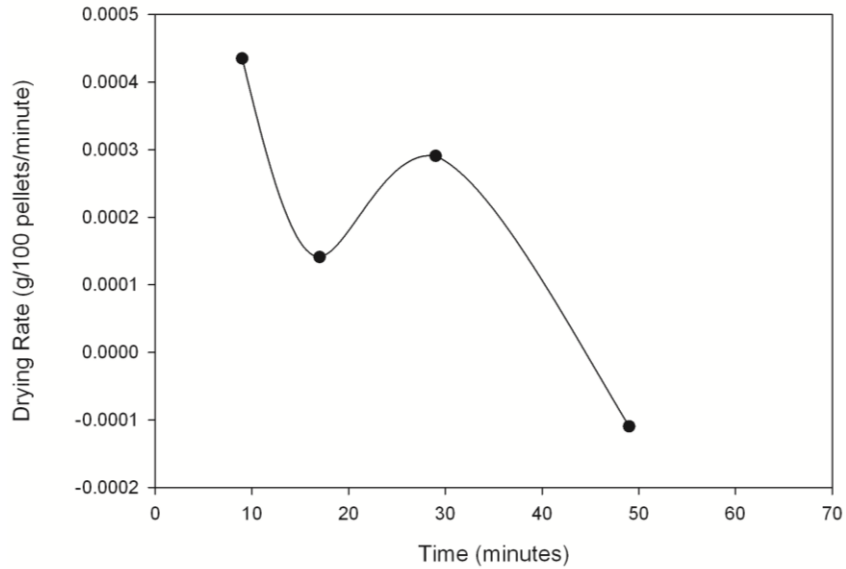
**Figure 3-3:** Measured (a) and theoretical (b) film coat thickness per pellet

Pellet fluidization is important to ensure good particle mixing and for good heat and mass transfer rates. Figure 3-4 compares the operational superficial gas velocity with the minimum fluidization velocity calculated using the measured mass of a pellet averaged over 100 pellets from a sample. The operational superficial gas velocity was always higher than the calculated minimum fluidization velocity.



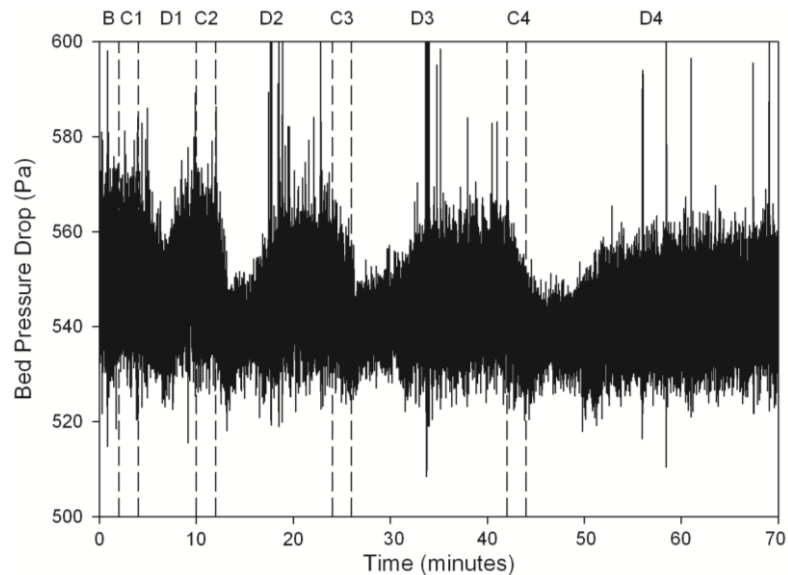
**Figure 3-4:** Operational superficial gas velocity compared to theoretical minimum fluidization velocity

Effective drying allows for the desired film coat to form around each individual pellet after each coating period. Samples removed during the drying periods allowed the drying rate to be estimated. As shown in Figure 3-5, the drying rate decreased with time.



**Figure 3-5:** Estimated drying rate

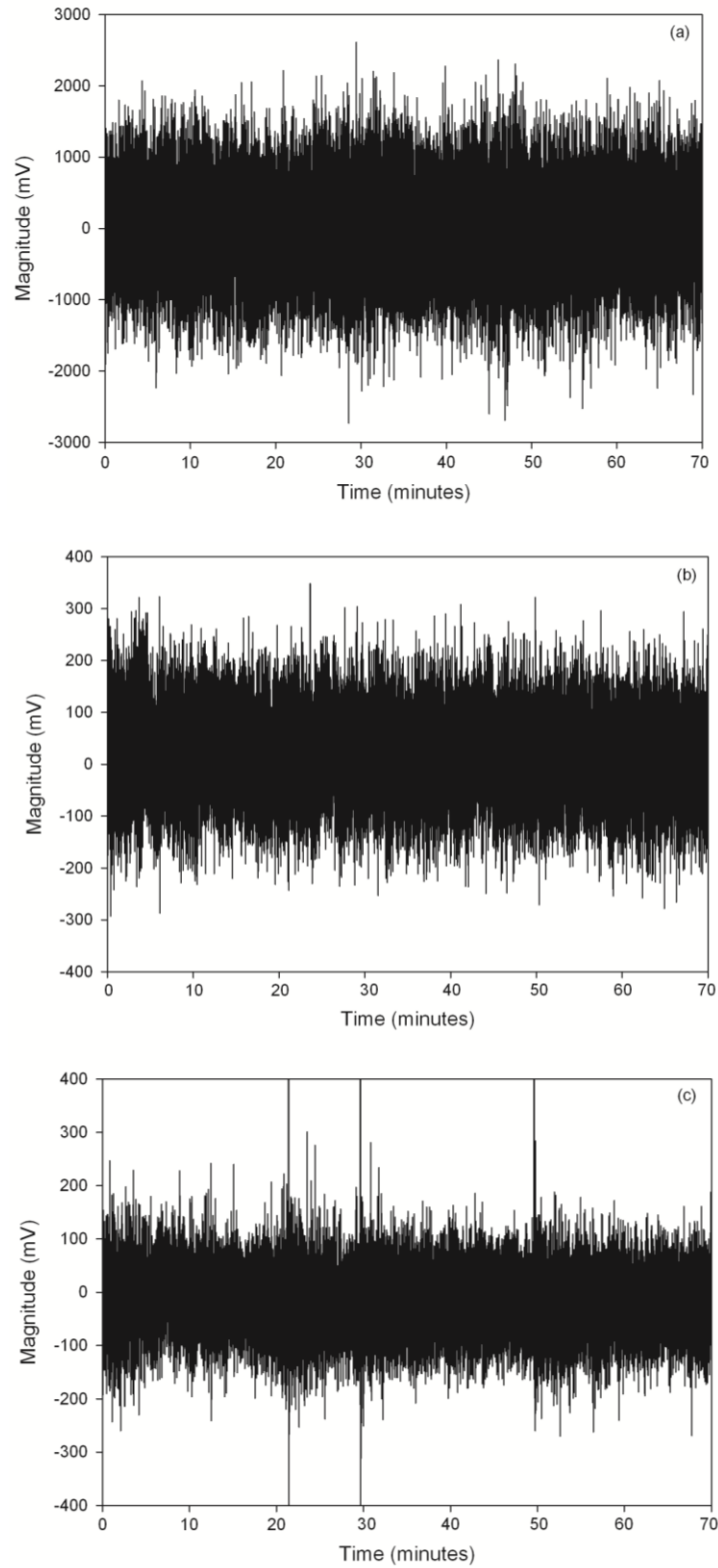
The pressure drop across the bed, shown in Figure 3-6, confirmed the bed remained fluidized throughout a trial. Shifts in the signal were observed when the coating spray was turned on and off, but stabilized after a few minutes. Visual observation through a window in the side of the bed also confirmed that the bed remained fluidized.



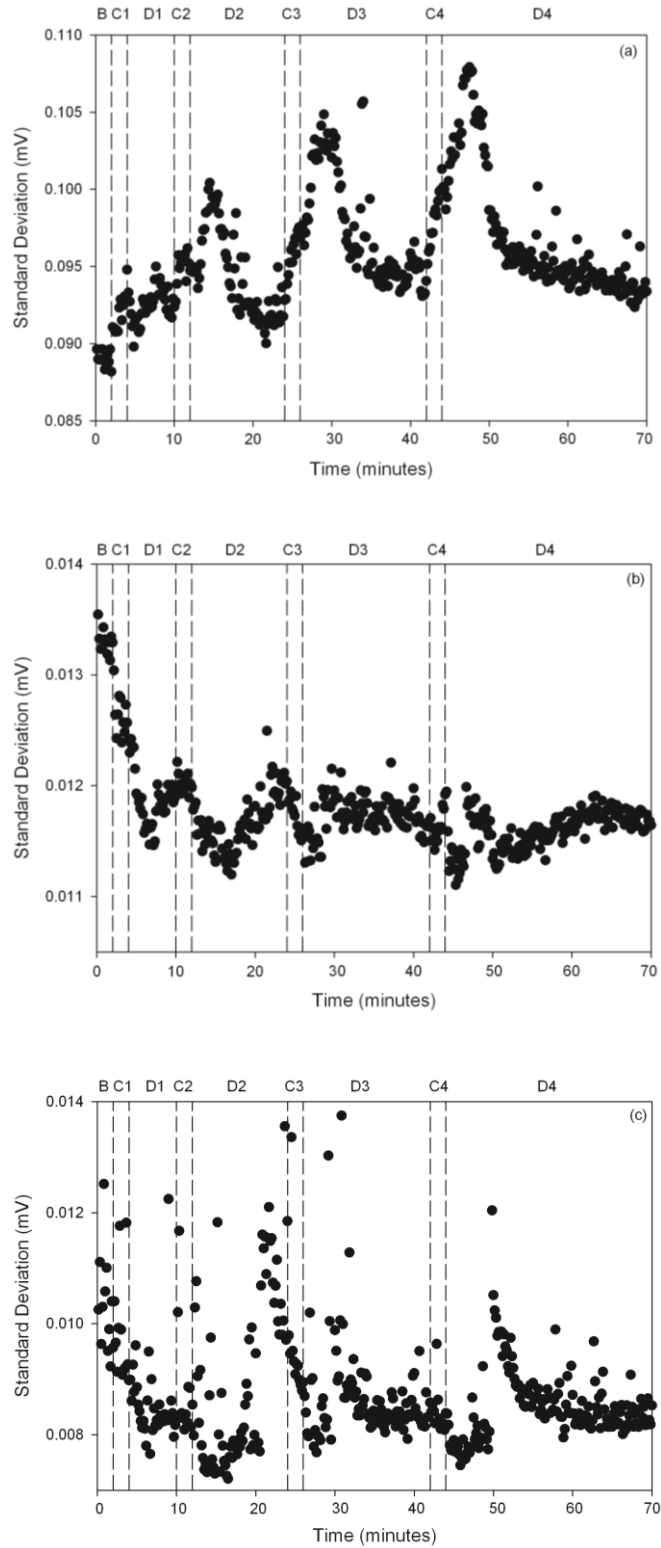
**Figure 3-6:** Measured pressure drop across the bed

Passive acoustic emission measurements provide a non-invasive, real-time means of obtaining process information. Figure 3-7 shows the passive acoustic emissions measured at the exhaust, interface and grid. The range in amplitude was five times greater for acoustic emissions acquired at the exhaust compared to microphones attached flush to the exterior of the column at the interface and grid. Identification of features within the signals that correspond to the coating process was difficult indicating the need for signal analysis to extract information.

Statistical and frequency analyses of the acoustic emissions were examined. Considering on-line implementation and the ability to provide real-time feedback, a statistical analysis was chosen. Specifically, an important balance between processing time and information provided was achieved when analyzing the standard deviation of the emissions signal compared to the more complex frequency analysis technique. Figure 3-8 shows the standard deviation of the passive acoustic emissions, over 10 second consecutive intervals, measured at the exhaust, interface and grid. For the emissions in the exhaust, shifts in the standard deviation were easily and clearly identified that corresponded to the spraying and drying periods. Shifts in the standard deviation that corresponded to spraying and drying periods were also obtained for emissions measured at the interface. Changes in the standard deviation that corresponded to operation modes of the bed were most difficult to identify using acoustic measurements at the grid.



**Figure 3-7:** Raw acoustic emissions signals obtained at the exhaust (a), interface (b) and grid (c)



**Figure 3-8:** Standard deviation of the acoustic emissions signals obtained at the exhaust (a), interface (b) and grid (c)

### 3.4 Discussion

Figure 3-3a and 3-3b identify the difference in measured and theoretical coat thickness values. The theoretical coat thickness was always larger than the measured value, indicating a final thickness approximately 6 times greater than the measured value after the fourth coating period; some of the liquid coating spray did not contribute to the formation of the film coat and may have coated the walls of the equipment rather than the pellets. There was some variability in the measured coat thickness especially near the beginning of the process. This reflected difficulties in obtaining representative samples from the bed and also the time required for the coating to be distributed throughout the bed. The spray was applied to the top of the fluidized bed. If the bed was well fluidized then the pellets were constantly moving allowing the surface of the bed to be refreshed and bringing many pellets into the spray zone. Coating liquid could also be transferred from pellet to pellet as the pellets move and contact each other within the bed. There was still some variability in the measured coat thickness near the end of the process: difficulties obtaining representative samples still remained, but lower fluidization quality hindered distribution of the coating liquid through pellet-pellet contact and transfer.

The pellets gained mass as the coating was applied. This increase in mass required a higher superficial gas velocity to reach minimum fluidization as calculated using Ergun's equation [26]. Over the entire coating process, the calculated minimum fluidization velocity increased by approximately 25% (Figure 3-4). As the operational superficial gas velocity remained constant, this meant that the fluidization behavior of the pellets changed with time. The bed was vigorously fluidized with pellets moving rapidly within the bed at the beginning while pellet movement was slower at the end of the process. This decrease in pellet movement had a negative impact on the coating process as uniform coating can only be achieved with fast renewal of pellets within the spray zone and significant contact and transfer of the liquid coating between pellets within the bed.

During the drying periods, some of the water was evaporated from the pellet surface leaving the sugar to form the coating film. The mass of the pellets correspondingly decreased and fluidization improved. In addition, drying reduced the stickiness of the film coat. A sticky coating on the pellet increased friction between the pellets, which



hindered fluidization. As shown in Figure 3-5, the drying rate decreased with time. As the fluidization quality decreased with the mass gain of the pellets from the film coat, the drying air no longer contacted the pellets as efficiently. During the last drying period, D4, a negative drying rate of 0.000109 g/min per 100 pellets was measured. This measurement highlighted the reduction in fluidization quality and therefore drying efficiency with process time, as well as difficulties obtaining representative samples especially when the bed was not vigorously fluidized.

Although the bed remained fluidized throughout the entire process, validated by the observed stable pressure drop within the bed (Figure 3-6), the overall fluidization quality decreased. Fluctuations in the pressure signal were observed after each coating period as the bed became wet and less stable, but improved after a few minutes. The overall fluidization quality negatively impacted the distribution and uniformity of the coating and also hindered its drying. In addition, as the coated pellets velocity within the bed decreased, it was more difficult to obtain representative samples. Sampling and off-line analyses was thereby more inaccurate, indicating a more critical need to accurately and reliably monitor the process to determine an optimum end. This highlights the importance of developing another technology for monitoring fluidized bed coating of pellets.

Figure 3-7 shows the passive acoustic emissions measured at the exhaust, interface and grid. The amplitude of the fluctuations was much larger for measurements at the exhaust compared to those at the interface and grid. Attenuation was minimized at the exhaust as the emissions only travelled through the freeboard and filter cloth before capture by the microphone. There was significant attenuation through the equipment walls for the externally located microphones at the interface and the grid, resulting in measurements with much lower amplitudes. Similar results were obtained by Hansuld et al. [22] and Briens et al. [24] for passive acoustic emissions recorded in the exhaust versus externally on a high shear granulator bowl. Additionally, the amplitude of the emissions measured at the interface was slightly larger than that measured at the grid. At the interface, the pellets move relatively easily and high frequency, high energy pellet-pellet and pellet-equipment wall collisions occurred, resulting in relatively large acoustic emissions. At

the grid, pellet motion was slower, collisions less frequent and at lower energies, corresponding to smaller acoustic emissions.

Statistical and frequency analyses were investigated to extract process information from the acoustic emission measurements. The measurements were divided into 10 second consecutive intervals for analysis. This interval was selected as a balance between sufficient information within an interval for reliable analysis and conclusions about the process versus response time for control. Similarly, analyses were also selected with the criterion for fast and automatic computational time to allow future incorporation into monitoring and control systems.

The standard deviation offers fast and automatic computations and, as shown in Figure 3-8, extracted information from the acoustic emissions that correlated with process conditions. The standard deviation reflected fluctuations in the measurements both in amplitude and frequency. Each of the locations showed a unique response as different aspects of the process were measured and highlighted.

Figure 3-8a shows the standard deviation of the acoustic emissions measured at the exhaust. The standard deviation increased during the coating periods and decreased during the later drying periods. The acoustic emissions measured by the microphone at this location had significant contributions from pellet-pellet and pellet-equipment wall collisions near the bed surface as well as from the spray exiting the nozzle and impacting on the bed surface. The spray added to the acoustic emissions from the bed creating a complex signal, increasing the standard deviation when the spray was turned on. The hydrodynamics of the bed changed with time as fluidization became more difficult with the weight gain of the pellets from the film coat. Fewer pellet collisions with less energy at the bed surface decreased this contribution to the measured acoustic emissions. The relative contribution of the spray to the measured acoustic emission thereby increased over time and this was reflected in the larger changes in the standard deviation during the spray periods near the end of the process. Acoustic emissions measured at the exhaust could be used for monitoring the spray performance specifically to detect nozzle clogging which would negatively impact the coating process.

Figure 3-8b shows the standard deviation of the acoustic emissions measured at the interface where the spray impacted upon the fluidized bed surface. The different profile at this location compared to the exhaust highlights that contributions to the measured acoustic emissions will change with sensor location. At this location, the dominant contribution was from pellet-pellet and pellet-equipment wall collisions near the surface of the fluidized bed. During the spray periods, the standard deviation decreased while it increased during the drying periods. During spraying, the pellets at the bed surface in the spray zone became coated in the solution. Their mass increased, but their velocity decreased resulting in fewer collisions with overall less energy. During the drying periods, the film coat began to dry. The pellets lost mass due to evaporation of the water and began to move more rapidly with more collisions at higher velocities or energy levels. The last spraying period, C4, was difficult to identify. At this point the pellets within the bed remained wet and coating and fluidization was difficult.

Acoustic emissions measured at the interface where the spray impacts upon the bed surface could be used to provide information about interactions within the spray zone, which have a direct relation to the distribution and uniformity of the coating on the pellets. Large changes in the standard deviation during the spraying and drying periods indicate good fluidization with excellent distribution of the coating liquid followed by efficient drying. Small changes in the standard deviation can indicate poor fluidization and the need to increase the superficial gas velocity to ensure optimum process conditions.

Figure 3-8c shows the standard deviation of the acoustic emissions measured near the grid. The profile was similar to 3-8b as this location reflected fluidization quality, but a much larger range in the standard deviation was observed and changes with process conditions were more difficult to identify. In addition changes in the standard deviation did not always correspond exactly to the coating and drying periods reflecting the time required for the coating solution applied at the bed surface to be distributed and start to impact the behavior of pellets near the grid. However, as defluidization usually occurs first near the grid [27] information about fluidization quality at this location can be valuable.

The acoustic emissions profiles observed for the model pellet system will be similar to profiles using pharmaceutical pellets. The diameters of pharmaceutical pellets are comparable to the model glass pellets, but the densities are usually lower. The lower density pellets would produce passive acoustic emissions with lower amplitudes. The profiles, however, should remain similar with distinct features reflecting the coating and drying phases and the bed dynamics.

### 3.5 Conclusions

Poor sampling and off-line analyses indicate the need for developing reliable monitoring systems for the coating of pharmaceutical pellets in a fluidized bed to determine an optimum coating end-point. Fluidization quality greatly influences the distribution of coating among individual pellets, as well as the efficiency of the drying air to contact wet pellets. Microphones attached externally to a fluidized bed at various positions showed different passive acoustic emission profiles during pellet coating providing information on nozzle performance and reflecting local fluidization conditions. A statistical analysis of the acoustic emissions was chosen to provide a balance between information provided and computational time, considering future implementation into monitoring and control systems. Acoustic emissions measured at the exhaust of a fluidized bed may indicate nozzle clogging, while measurements at the interface of the spray and fluidized pellet bed indicate poor fluidization conditions, suggesting a change in the operational parameters to improve fluidization. Passive acoustic emissions measurements show potential as a tool for monitoring the coating of pharmaceutical pellets in a fluidized bed on-line and in real-time. Further development of this monitoring tool would provide valuable information about fluidized bed coating of pellets and allow better control of the process to help ensure optimum performance.

### 3.6 References

[1] E. Teunou, D. Poncelet, Batch and continuous fluid bed coating – review and state of the art, *Journal of Food Engineering*, 53 (2002) 325-340.

- [2] F. Depypere, P. Van Oostveldt, J.G. Pieters, K. Dewettinck, Quantification of microparticle coating quality by confocal laser scanning microscopy (CLSM), *European Journal of Pharmaceutics and Biopharmaceutics*, 73 (2009) 179-186.
- [3] G. Perfetti, E.V.d. Castele, B. Rieger, W.J. Wildeboer, G.M.H. Meesters, X-ray micro tomography and image analysis as complementary methods for morphological characterization and coating thickness measurement of coated particles, *Advanced Powder Technology*, 21 (2010) 663-675.
- [4] M.-J. Lee, D.-Y. Seo, H.-E. Lee, I.-C. Wang, W.-S. Kim, M.-Y. Jeong, G.J. Choi, In line NIR quantification of film thickness on pharmaceutical pellets during a fluid bed coating process, *International Journal of Pharmaceutics*, 403 (2011) 66-72.
- [5] C.V. Liew, L.K. Wang, P. Wan Sia Heng, Development of a visiometric process analyzer for real-time monitoring of bottom spray fluid-bed coating, *Journal of Pharmaceutical Sciences*, 99 (2010) 346-356.
- [6] P. Pandey, M. Katakdaunde, R. Turton, Modeling weight variability in a pan coating process using Monte Carlo simulations, *AAPS PharmSciTech*, 7 (2006) E2-E11.
- [7] M. Hemati, R. Cherif, K. Saleh, V. Pont, Fluidized bed coating and granulation: influence of process-related variables and physicochemical properties on the growth kinetics, *Powder Technology*, 130 (2003) 18-34.
- [8] D. Jones, Air Suspension Coating for Multiparticulates, *Drug Development and Industrial Pharmacy*, 20 (1994) 3175-3206.
- [9] K. Naelapää, P. Veski, J.G. Pedersen, D. Anov, P. Jørgensen, H.G. Kristensen, P. Bertelsen, Acoustic monitoring of a fluidized bed coating process, *International Journal of Pharmaceutics*, 332 (2007) 90-97.
- [10] M.R. Parise, C.A.M. Silva, M.J. Ramazini, O.P. Taranto, Identification of defluidization in fluidized bed coating using the Gaussian spectral pressure distribution, *Powder Technology*, 206 (2011) 149-153.

- [11] C.A.M. Silva, M.R. Parise, F.V. Silva, O.P. Taranto, Control of fluidized bed coating particles using Gaussian spectral pressure distribution, *Powder Technology*, 212 (2011) 445-458.
- [12] J.F. Nunes, C.A.M. da Silva, S.C.S.R. Silva Moris, O.P. Taranto, Spectral analysis of pressure drop fluctuation in vibrofluidized bed coating, *Chemical Engineering Transactions*, (2011) 649-654.
- [13] M. Možina, D. Tomažević, S. Leben, F. Pernuš, B.t. Likar, Digital imaging as a process analytical technology tool for fluid-bed pellet coating process, *European Journal of Pharmaceutical Sciences*, 41 (2010) 156-162.
- [14] M. Andersson, B. Holmquist, J. Lindquist, O. Nilsson, K.-G. Wahlund, Analysis of film coating thickness and surface area of pharmaceutical pellets using fluorescence microscopy and image analysis, *Journal of Pharmaceutical and Biomedical Analysis*, 22 (2000) 325-339.
- [15] F.L. Laksmana, L.J. Van Vliet, P.J.A. Hartman Kok, H. Vromans, H.W. Frijlink, K. Van der Voort Maarschalk, Quantitative Image Analysis for Evaluating the Coating Thickness and Pore Distribution in Coated Small Particles, *Pharmaceutical Research*, 26 (2009) 965-976.
- [16] Food and Drug Administration, *Guidance for Industry: PAT a framework for innovative pharmaceutical development, manufacturing and quality assurance*, DHHS, Rockville, MD, 2004.
- [17] A. Bogomolov, M. Engler, M. Melichar, A. Wigmore, In-line analysis of a fluid bed pellet coating process using a combination of near infrared and Raman spectroscopy, *Journal of Chemometrics*, 24 (2010) 544-557.
- [18] L.E. Kinsler, A.R. Frey, A.B. Coppens, J.V. Sanders, *Fundamentals of Acoustics*, Wiley-VCH, 1999.

- [19] J. W.R. Boyd, J. Varley, The uses of passive measurement of acoustic emissions from chemical engineering processes, *Chemical Engineering Science*, 56 (2001) 1749-1767.
- [20] H. Tsujimoto, T. Yokoyama, C.C. Huang, I. Sekiguchi, Monitoring particle fluidization in a fluidized bed granulator with an acoustic emission sensor, *Powder Technology*, 113 (2000) 88-96.
- [21] E.M. Hansuld, L. Briens, J.A.B. McCann, A. Sayani, Audible acoustics in high-shear wet granulation: Application of frequency filtering, *International Journal of Pharmaceutics*, 378 (2009) 37-44.
- [22] E.M. Hansuld, L. Briens, A. Sayani, J.A.B. McCann, An investigation of the relationship between acoustic emissions and particle size, *Powder Technology*, 219 (2012) 111-117.
- [23] L. Briens, D. Daniher, A. Tallevi, Monitoring high-shear granulation using sound and vibration measurements, *International Journal of Pharmaceutics*, 331 (2007) 54-60.
- [24] S. Matero, S. Poutiainen, J. Leskinen, K. Järvinen, J. Ketolainen, S.P. Reinikainen, M. Hakulinen, R. Lappalainen, A. Poso, The feasibility of using acoustic emissions for monitoring of fluidized bed granulation, *Chemometrics and Intelligent Laboratory Systems*, 97 (2009) 75-81.
- [25] D. Vervloet, J. Nijenhuis, J.R. van Ommen, Monitoring a lab-scale fluidized bed dryer: A comparison between pressure transducers, passive acoustic emissions and vibration measurements, *Powder Technology*, 197 (2010) 36-48.
- [26] S. Ergun, Fluid flow through packed columns, *Chemical Engineering Progress*, (1952) 89-94.
- [27] C.L. Briens, S. Barghi, Defluidized zones in liquid–solid fluidized beds, *Powder Technology*, 114 (2001) 186-196.

## Chapter 4

### 4 Passive Acoustic Emissions Monitoring of Pellet Coat Thickness in a Fluidized Bed

#### 4.1 Introduction

Pharmaceutical pellets are often coated and packed into capsules as a multiple unit dosage form for oral consumption. The active ingredient is usually contained within the pellets, which are spherical in shape and range in size from 100 to 1000  $\mu\text{m}$  in diameter. Coating is performed to provide a variety of functions including modified drug release, mechanical integrity, to protect the active ingredient, and to provide a more aesthetically appealing dosage form [1]. The coating film thickness, uniformity and overall quality are significant factors to the function of modified drug release and behaviour of the dosage form *in vivo* [2-4]. Coated pellets packed into a capsule have various advantages over the conventional tablet, including minimal variations in gastro intestinal transit time, the ability to minimize dosage dumping and an increased flexibility in drug formulation and design [5]. Potent drugs with critical dosages rely heavily on these factors for accurate and safe delivery.

Pharmaceutical coating is achieved in either a rotated drum pan coater or fluidized bed coater equipped with a top spray, bottom spray or rotating spray nozzle. Large particles, such as tablets, are typically coated in a rotated drum pan coater [6], while smaller particles, such as pellets, are better suited to be coated in a fluidized bed. The pellets are lighter and easier to fluidize resulting in good particle mixing, ideal for fluidized bed coating. An atomized liquid solution is sprayed onto the pellet bed, while the heated fluidizing air evaporates the solvent allowing for the solute to act as a coating medium around the pellet core [1].

Fluidized bed coating is characterized by the complex interaction of gas, liquid and solid phases. It is important to find the appropriate balance between operating parameters to ensure the final product meets the desired design specifications. This includes monitoring and/or controlling the inlet/outlet air temperature, inlet/outlet air humidity, superficial gas



velocity, atomizing air pressure, spray rate and droplet size [7]. The difficulty associated with the complex interaction of these parameters highlights the need for developing an on-line, real-time monitoring system to improve process control and to provide additional insight into process behaviour. Top spray fluidized beds are typically associated with random particle flow resulting in non-uniform coating and an increased potential for bed defluidization [1,8,9]. Such issues identify the need for developing new process monitoring and control techniques for top spray fluidized beds.

Evaluation of the film coating involves sample removal to estimate the film coat thickness based on a difference in mass or through dissolution and/or disintegration testing [10]. These methods are typically used to evaluate coated tablets and are associated with many weaknesses when applied to the evaluation of coated pellets: (i) it is difficult to accurately measure the small differences in weight, (ii) no variations within or between pellets are considered, (iii) attrition and loss of coating are not accounted for, (iv) indirect measurements are provided when performing disintegration and/or dissolution testing, and (v) no information about coat quality is given. Overall, these techniques require invasive sampling and time-consuming measurements and therefore, are unable to provide real-time information necessary for process control.

A variety of imaging and spectroscopic methods have been explored to improve these measurement techniques and to evaluate the pellet film coatings including fluorescence microscopy [11], digital imaging [10], confocal laser scanning microscopy (CLSM) [2,12], X-ray micro tomography [3] and Raman spectroscopy [13]. Conventional image analysis techniques, such as fluorescence microscopy, are typically limited to the pellet surface preventing a full analysis of the film coat, or require slicing of the pellet into segments destroying the pellet completely [2]. CLSM in combination with other image analysis techniques have been explored by both Depypere et al. [2] and Laskmana et al. [12] as a non-destructive imaging technique. The described methods required invasive sampling, fluorescent labeling, off-line analyses and extensive image processing, limiting industrial applications. Perfetti et al. [3] studied the feasibility of X-ray micro tomography and was able to non-destructively produce high resolution 3-D images but required complex mathematical algorithms for image reconstruction, as well as expensive

X-ray equipment and technology. Sovány et al. [13] encountered issues with the use of Raman spectroscopy due to the weakening of the Raman signal from scattered light and the difference in size between the pellet and large laser spot. As well, the characteristic peaks of the active ingredient overlapped with peaks of the coating material leading to inconclusive results [13]. Overall, these studies have led to important discoveries regarding fluidized bed pellet coating, but still require disruptive in-process sampling or invasive measurement acquisition, as well as time consuming off-line testing and analyses.

The pharmaceutical industry has been moving towards the development and implementation of process analytical technologies (PATs) for the improvement of pharmaceutical manufacturing, development, and quality assurance in accordance with the Food and Drug Administration's ICH guidelines Q8 [14]. The objective of these efforts is to develop more robust manufacturing that applies an increased understanding of the science behind each process, improving the overall cost-effectiveness and minimizing loss of product or failed batches with better process control.

PAT techniques that have been explored for pellet coating in a fluidized bed include near infrared spectroscopy [4], near infrared spectroscopy combined with Raman spectroscopy [15] and passive acoustic emissions monitoring [9]. Both spectroscopic methods require an invasive measurement probe or window into the unit leading to inaccurate measurements and contamination issues, as well as the need for equipment modifications. Bogomolov et al. [15] found wet pellets to influence light propagation, interfering with the measurements; a high level of moisture corresponded to lower spectra intensity due to increased incident light penetrating the coating material. A study by Kato et al. [16] identified different coating formulations, variations in coat thickness and the amount of coating applied to influence the accuracy of NIR spectra. Furthermore, Depypere et al. [2] identified NIR to have a limited spatial resolution, unable to obtain accurate measurements of thin coating layers in the range of 25 to 75  $\mu\text{m}$ .

The application of acoustic emissions as an on-line monitoring and control technique has been proven useful in the chemical, biochemical and food industries [7]. In general,

acoustics is characterized as the generation, transmission and reception of energy in the form of vibrational waves [17]. When applied as a monitoring tool, passive acoustic emissions provide a non-invasive and real-time means of collecting information about the physicochemical changes that take place within a process [18]. Pharmaceutical applications of acoustic emissions monitoring have been shown to be useful for high-shear and fluidized bed granulation, fluidized bed drying and mixing processes [19-25].

In the 1970's, Leach and Rubin studied passive acoustic emissions produced from the interaction between different sized particles [26-30]. This work led to the theory of passive acoustic emissions to be generated as a result of (i) particle-particle or particle-equipment collisions, (ii) friction from these collisions, and (iii) air turbulence from the fluidizing air [19]. In the case of fluidized bed coating of pellets, one study by Naelapää et al. [9] assessed the possibility of using passive acoustic emissions monitoring.

Vibrations produced during the coating of potassium chloride crystals were measured at different locations on the column using four accelerometers. The measurements were compared to an estimated coat thickness based on a theoretical amount of film coating applied and samples tested for dissolution. Although the technique showed promise, some issues with the experimental procedure were identified leading to inconclusive results: (i) repositioning of the sensors between batches led to signal differences, (ii) limited samples were removed and did not represent the entire batch and (iii) the amount of film coating applied was calculated based on a volume drop in coating solution and therefore indirectly estimated the film coat thickness.

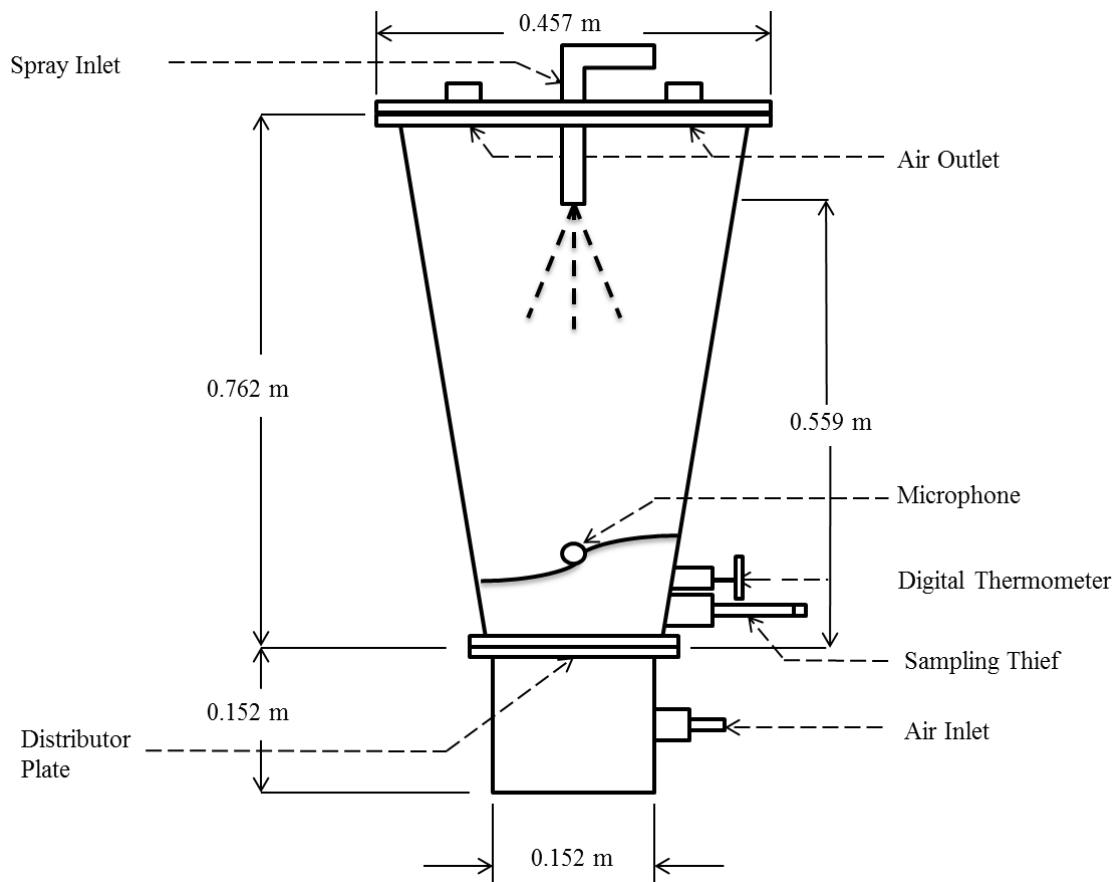
Our previous work assessed the feasibility of using passive acoustic emissions to monitor pellet coating in a fluidized bed, building from the study by Naelapää et al. [9]. It was concluded that passive acoustic emissions profiles could indicate local fluidization conditions and were also able to provide information about the spray nozzle performance. To our knowledge, there is limited research that focuses on the application of passive acoustic emissions to monitor specific properties of the film coating, such as the film coat thickness. The goal of this study was to expand on our previous work and to assess the possibility of determining a coating end-point related to the pellet film coat thickness

using passive acoustic emissions monitoring. Additional insight into the effect of the coating solution on the fluidized bed coating process was also explored.

## 4.2 Materials and Methods

### 4.2.1 Fluidized Bed

Coating was performed in a conical top spray fluidized bed, shown in Figure 4-1. Heated fluidizing air entered a wind box, before passing into the unit through a polyethylene distributor plate that had a pore size of  $75\ \mu\text{m}$ . The unit was equipped with an atomizing spray nozzle (John Brooks Company Limited, Reference #: 1/8 PRJJB 0.0390) located at the top of the column, 0.559 m above the distributor plate. The top of the column was equipped with four filtered air outlets.



**Figure 4-1:** Schematic of the top spray fluidized bed with equipment

#### 4.2.2 Coating Experiments

Glass pellets, 1000  $\mu\text{m}$  in diameter, were used as the solids for the coating experiments. These solids were easily reusable and, as shown in Table 4-1, had diameters similar to microcrystalline cellulose starter cores, called Cellets<sup>®</sup>. Cellets<sup>®</sup> are often commercially coated and used in pharmaceutical multiple unit dosage forms for modified drug release. Approximately 2 kg of glass pellets were coated during each trial.

The inlet air had a superficial gas velocity of 1.82 m/s to fluidize the pellets and was heated to a temperature of 35 °C with a humidity of approximately 15%. A 5% (w/w) sugar solution was used for coating. This coating solution was applied using a pressurized atomizing spray nozzle at a rate of approximately 15-20 mL/min, summarized in Table 4-2. Each coating stage consisted of a 2-4 minute coating spray period to ensure a detectable increase in coat thickness, followed by a 30 minute drying period.

Following the drying period of each coating stage, samples were removed to directly measure the film coat thickness based on a difference in mass, assuming a perfectly uniform and evenly distributed film coat among the pellets. 100 pellets were carefully counted and weighed. The pellets were then washed with 1000 mL of warm water at 35°C and dried on trays for about 20 hours at a temperature of 20°C and a humidity of 10%. Once dry, the pellets were re-weighed and the difference in mass was attributed to the mass of the coating. The film coat measurements were performed in triplicate.

Scanning electron microscope (SEM) images were taken of uncoated and coated pellets using a Hitachi S-4500 field emission scanning electron microscope at an accelerated voltage of 3.00 kV. Samples were mounted on a plate and coated with gold to improve the electrical conductivity prior to imaging. The images were used to confirm film coat formation and to provide insight into surface morphology.

**Table 4-1:** Material properties of uncoated glass pellets and Cellets®

	<b>Diameter (<math>\mu\text{m}</math>)</b>	<b>Mass per pellet (g)</b>	<b>Density (<math>\text{g}/\text{cm}^3</math>)</b>
<b>Glass Pellets</b>	1000	0.001257	2.400
	2000	0.010053	2.400
	3000	0.033929	2.400
	4000	0.080425	2.400
<b>Cellets® 1000</b>	1000 – 1400	0.000419	0.800

**Table 4-2:** Coating solution applied at each coating stage for Trial 1, Trial 2 and Trial 3

<b>Coating Stage</b>	<b>Applied Coating (mL)</b>		
	<b>Trial 1</b>	<b>Trial 2</b>	<b>Trial 3</b>
1	36	69	70
2	38	36	67
3	76	40	31
4	34	31	32

#### 4.2.3 Acoustic Data Acquisition

Passive acoustic emissions were recorded using a piezoelectric microphone (PCB Piezotronics Model 130P10) connected to a National Instruments data acquisition system equipped with LabVIEW software. A microphone was attached flush to the exterior of the column 0.150 m above the distributor plate. This height corresponded approximately to the height of the fluidized bed. Previous work showed acoustic emissions measured at this location provided important information about the fluidized bed coating process [31].

Acoustic emissions were recorded at a sampling rate of 40 000 Hz to ensure full reconstruction of emissions within the audible frequency range (20 – 20 000 Hz) without aliasing.

#### 4.2.4 Signal Analysis

The acoustic emissions profiles of pellets coated to different coat thicknesses in the fluidized bed were acquired at varying superficial gas velocities. Prior to data acquisition, the pellets were fluidized for 5 minutes to ensure stable bubbling conditions. The acquired data was then divided into twenty 6 second segments to determine the average amplitude of the emissions for each coat thickness and superficial gas velocity.

#### 4.2.5 Supplemental Experiments

The effect of mass on the amplitude of acoustic emissions produced from pellet-wall collisions for a single pellet or group of pellets was assessed for glass pellets of varying diameters, summarized in Table 4-1. For each trial, performed in triplicate, a single pellet was dropped 10 cm above a metal plate, ten times. A piezoelectric microphone attached flush to the exterior of the bottom of the metal plate recorded acoustic emissions from the collisions. The process was repeated, in triplicate, to include pellet-pellet interactions by simultaneously dropping a group of 10 pellets, ten times. Additionally, a sugar solution was sprayed onto the metal plate to simulate the loss of coating onto the column wall. The collisions experiments were repeated for the 1000  $\mu\text{m}$  diameter glass pellets to indicate the possible effect of the coating spray on the column wall on the amplitude of the acoustic emissions.

The effect of the wet coating on pellet flowability was also assessed and measured in triplicate using a Mercury Scientific Revolution Powder Analyzer. Samples were removed immediately after the coating period, referred to as *wet pellets*, midway through the drying period, referred to as *half wet pellets*, and at the end of the drying period, referred to as *dry pellets*. A sample size of 40  $\text{cm}^3$  was rotated at 0.3 rpm in a transparent drum with a diameter of 5 cm and width of 3.5 cm until 128 avalanches had occurred. One avalanche was defined as the surface movement of 0.65 vol% of the sample within the drum. Flowability indicators, including avalanche time, were determined using

optical measurements of the powder surface at 60 frames per second and a resolution of 648x488.

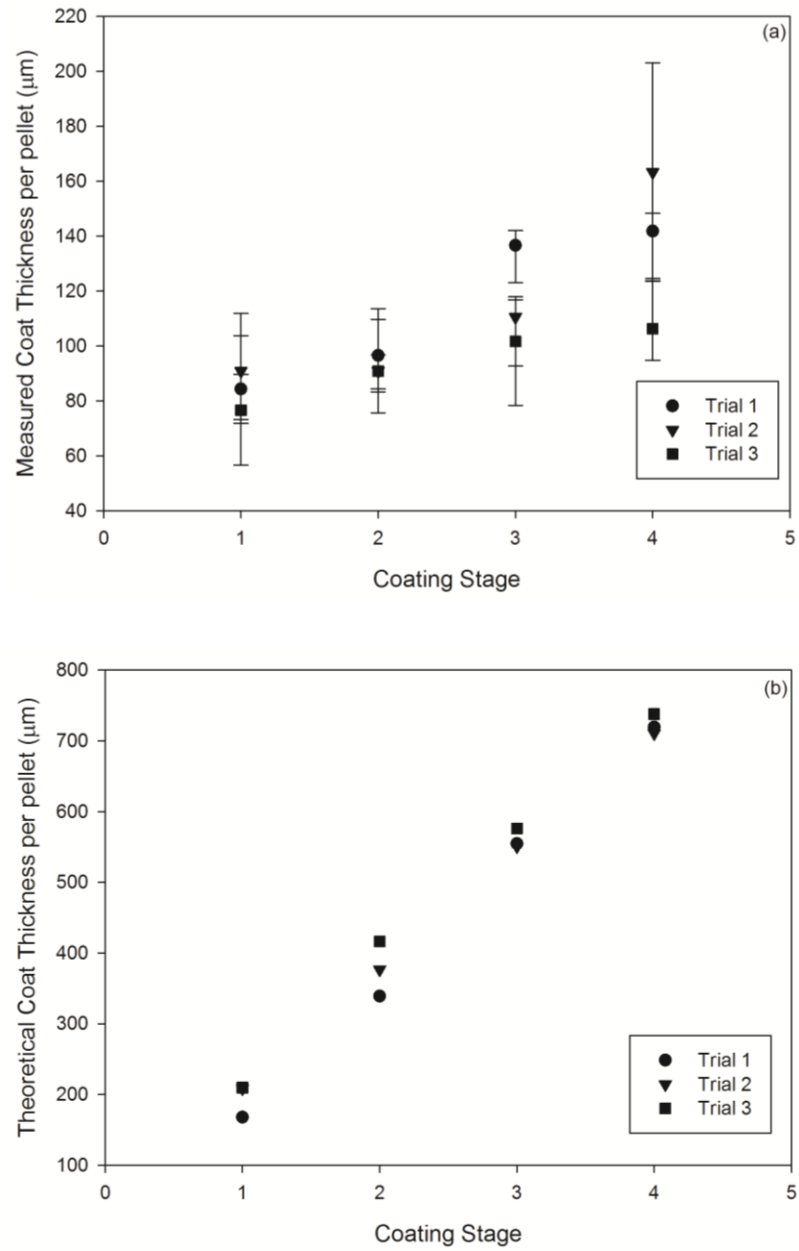
Passive acoustic emissions were acquired for fluidized Cellets<sup>®</sup> at an operational superficial gas velocity of 1.12 m/s, about 1.8 times greater than the minimum fluidization velocity. This operational superficial gas velocity was chosen to maintain the same ratio of gas velocity to minimum fluidization velocity as used for the glass pellets. The fill volume of the column was equal to the volume of glass pellets used for the previous experiments, corresponding to 1.15 kg of Cellets<sup>®</sup>. The acoustic emissions profile of the fluidized Cellets<sup>®</sup> was compared to the profiles obtained for the glass pellets to evaluate the effect of pellet composition on the passive acoustic emissions.

### 4.3 Results

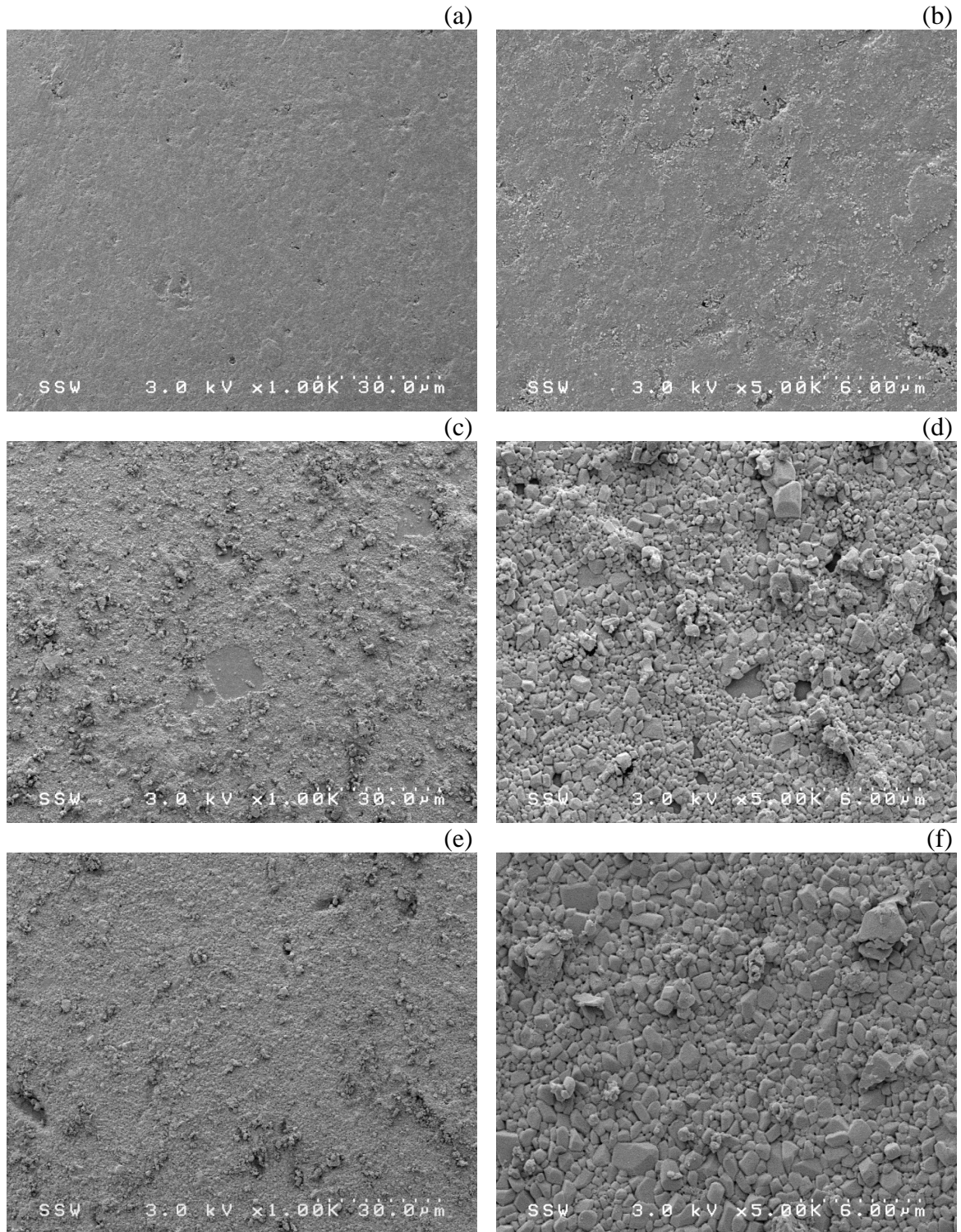
During each coating stage, the sugar solution began to form a film coat around the pellets; water evaporated during the drying period leaving the sugar behind as coating. Figure 4-2a shows increases in the measured coat thickness determined through increases in pellet mass as the applied coating accumulated, with measured coat thicknesses ranging from 50 – 200  $\mu\text{m}$ . Coat thicknesses approximately 4 times greater were estimated based on theoretical calculations using the volume of applied coating (Figure 4-2b).

SEM images of uncoated and coated pellets (Figure 4-3) visually confirmed the film coating. The surfaces of the uncoated glass pellets were smooth, shown in Figures 4-3a and 4-3b. Figures 4-3c and 4-3d show the surfaces of partially coated pellets: sugar crystals were observed on the surface with some of the glass pellet surface visible below. When the pellets were completely coated, shown in Figures 4-3e and 4-3f, sugar crystals were observed to cover the entire surface and the glass beneath was not visible.



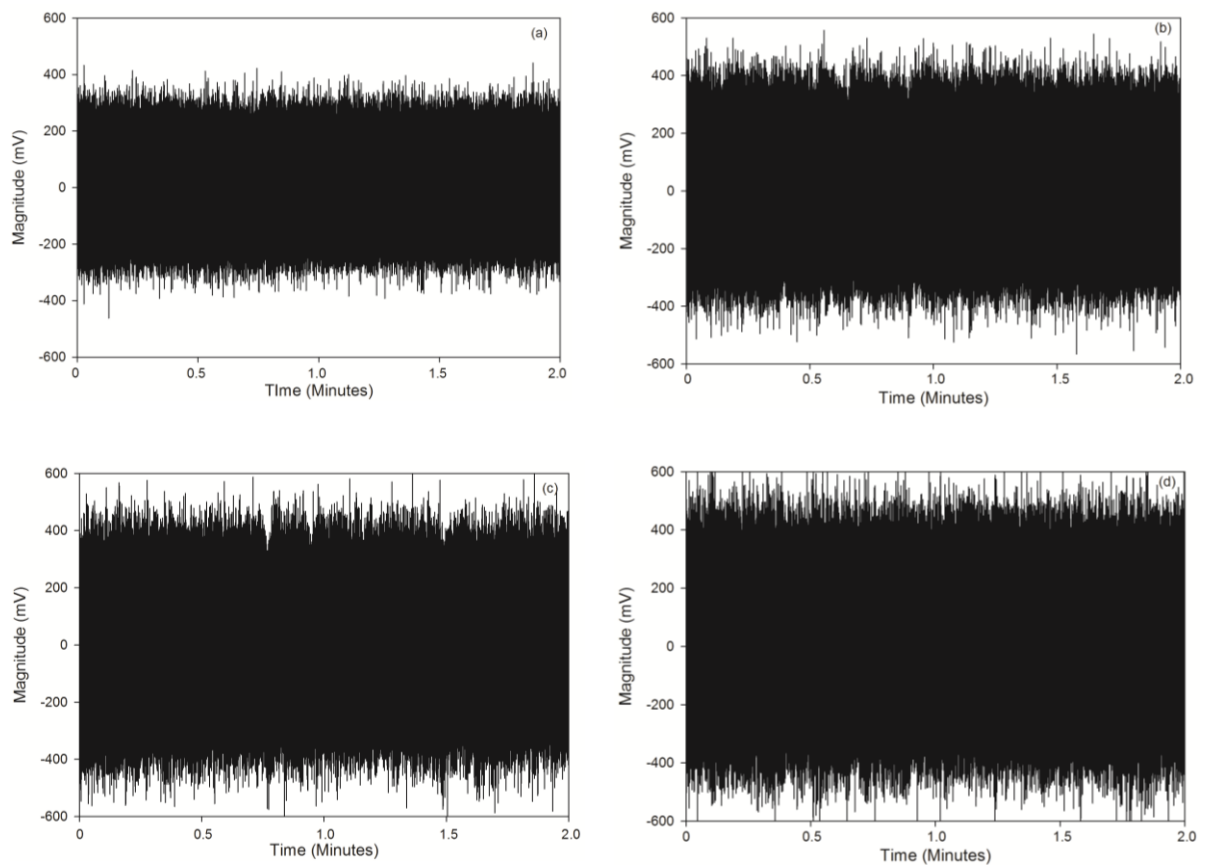


**Figure 4-2:** Measured (a) and theoretical (b) coat thickness per pellet at each coating stage



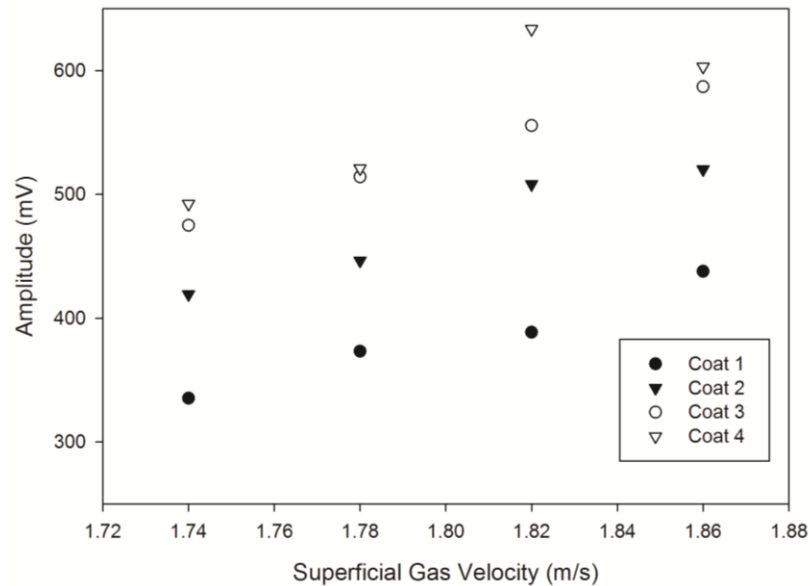
**Figure 4-3:** Scanning electron microscopy images of uncoated pellets (a,b), partially coated pellets (c,d) and coated pellets (e,f) at 1000x and 5000x magnification

Passive acoustic emissions from pellet-pellet and pellet-wall collisions provided information about the process dynamics. As the pellets became coated, the pellets changed in mass, volume and surface properties, which in turn affected the acoustic emissions. Figure 4-4 shows the change in acoustic emissions during the coating phase of each of the four coating stages for Trial 1 at a superficial gas velocity of 1.82 m/s. The amplitude of the acoustic emissions increased from approximately 350 mV during coating stage 1 to 550 mV in coating stage 4.



**Figure 4-4:** Magnitude of the raw acoustic emissions signal for Trial 1: coating stage 1 (a), coating stage 2 (b), coating stage 3 (c) and coating stage 4 (d) over a 2 minute interval at a superficial gas velocity of 1.82 m/s

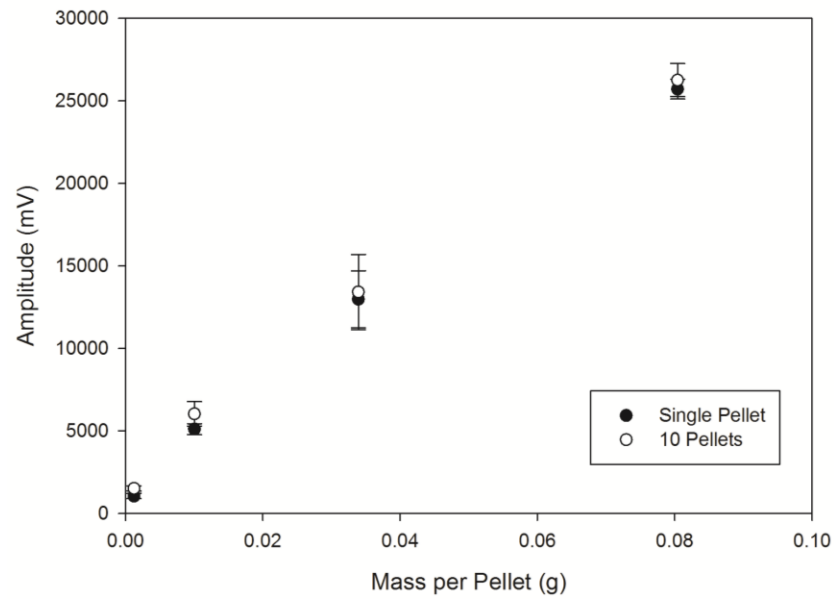
Figure 4-5 summarizes the average amplitude of the acoustic emissions during the four coating stages at different superficial gas velocities. Overall, the amplitude increased with each coating stage and with an increase in superficial gas velocity. Replicate trials confirmed these trends.



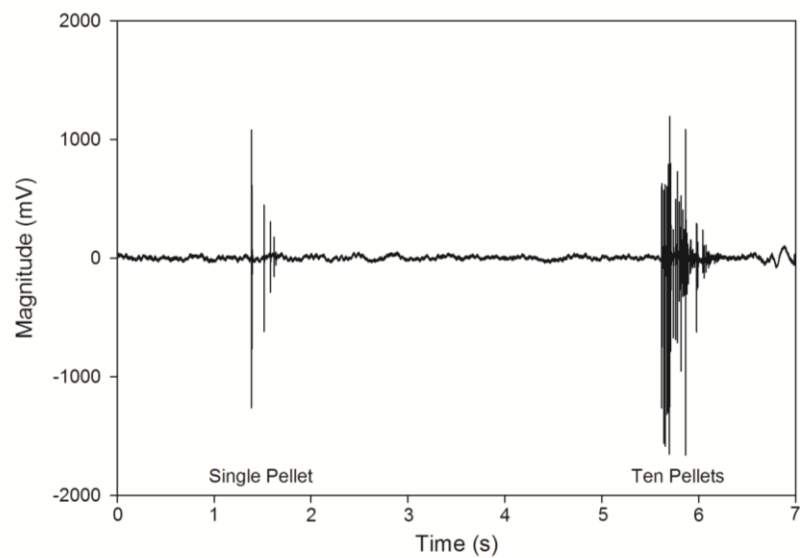
**Figure 4-5:** Amplitude of acoustic emissions produced at each coating stage and varying superficial gas velocities

Separate tests were designed to investigate the effect of mass on the passive acoustic emissions from pellet collisions. Figure 4-6 shows the measured amplitudes for uncoated glass pellets with varying diameters from collisions with a metal plate that simulates collisions with the column wall. Acoustic emissions amplitudes increased with greater pellet volume, corresponding to an increase in pellet mass.

Ten pellets dropped simultaneously produced a slightly greater amplitude with increased fluctuations than produced from the collision of a single pellet with the metal plate, shown in Figure 4-7. The first disturbance in the signal was a result of a single pellet colliding with the metal plate, while the second disturbance was a result of 10 pellets colliding with the metal plate.

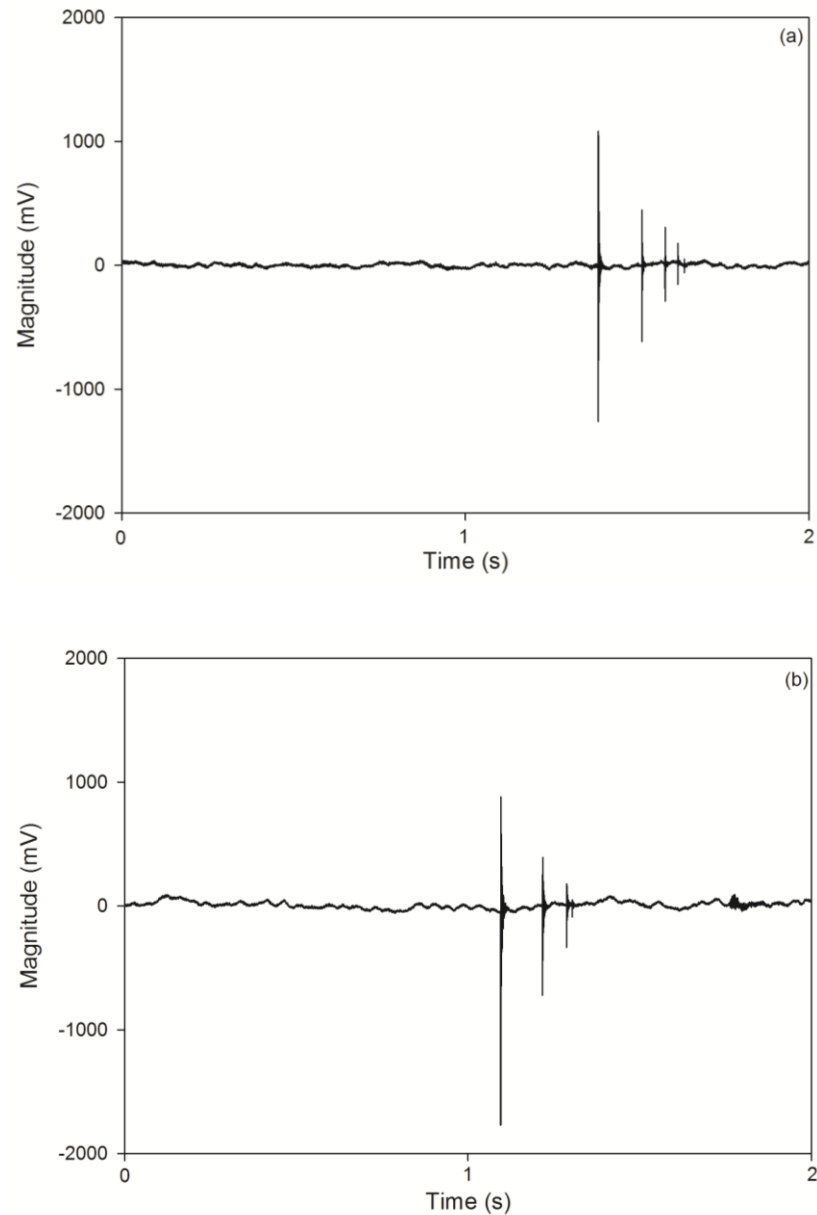


**Figure 4-6:** Amplitude of acoustic emissions produced from a single glass pellet or group of glass pellets with increasing pellet mass



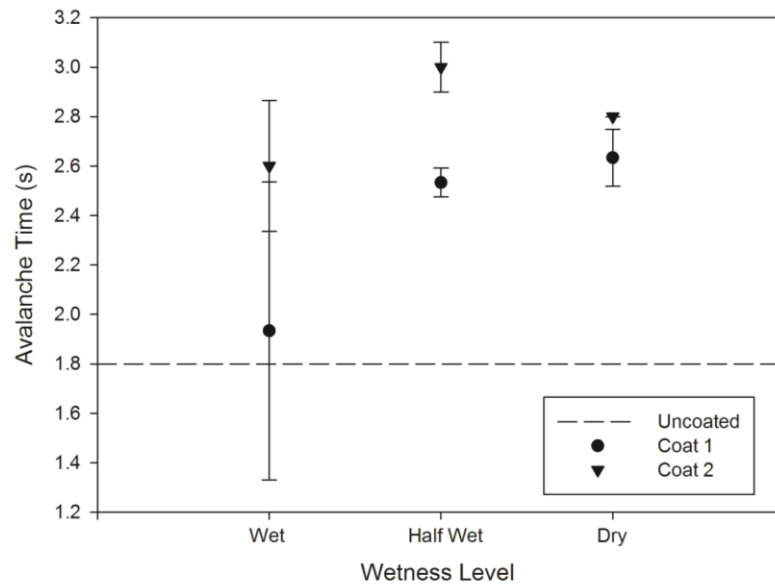
**Figure 4-7:** Raw acoustic emissions signal of a single pellet colliding with a metal plate and 10 pellets colliding with a metal plate

Additional tests were performed on a sugar coated metal plate to simulate the coated column wall. Figures 4-8a and 4-8b show the amplitude of a single pellet, 1000  $\mu\text{m}$  in diameter, colliding with an uncoated and sugar coated metal plate, respectively. Comparable amplitudes, within error, were observed for both the uncoated and coated metal plate.



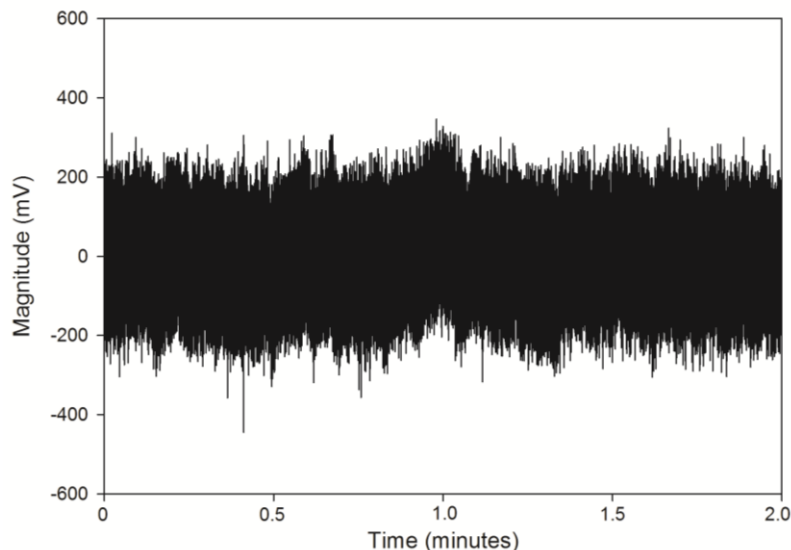
**Figure 4-8:** Raw acoustic emissions signal of a single pellet colliding with a metal plate (a) and a single pellet colliding with a sugar coated metal plate (b)

The fluidization quality was affected by pellet flowability. Figure 4- 9 shows the average avalanche time of uncoated pellets compared to coated pellets at three different coat wetness levels: *wet*, *half wet* and *dry*. The measured avalanche time for coated pellets was greater than the uncoated pellets due to a change in surface properties from the sugar coating. The avalanche time as the coating dried corresponded to changes in surface morphology and lubrication properties of the wet coating, affecting pellet flowability.



**Figure 4-9:** Avalanche time of coated pellets at different wetness levels compared to the baseline avalanche time of uncoated glass pellets

The raw acoustic emissions signal for a bed of fluidized Cellets<sup>®</sup> is shown in Figure 4-10. The amplitude of the signal was lower than the amplitudes observed for the fluidized glass pellets. Fluctuating fluidization conditions were observed through a window on the side of the column wall, corresponding to small shifts in the acoustic emissions signal.



**Figure 4-10:** Magnitude of the raw acoustic emissions signal for Cellets<sup>®</sup> fluidized at an operational superficial gas velocity of 1.12 m/s

#### 4.4 Discussion

Small and controlled changes in coat thickness are desired as modified release dosage forms can rely on coat thickness to provide specific drug release profiles *in vivo*. Figure 4-2a shows small increases in the measured coat thickness with each coating stage, confirming the formation of a film coat as coating progressed. The measured values were much lower than the theoretical coat thickness values, shown in Figure 4-2b, suggesting a significant portion of the coating spray impacted and then coated the column wall instead of coating the fluidized pellets. The significant loss of coating solution onto the column wall was also seen through comparing the differences between trials and coating stages. For example during coating stage 1, approximately twice the volume of coating solution was added for Trials 2 and 3 compared to Trial 1. The measured coat thickness from this coat stage however, was not significantly different; a large volume of coating solution was lost to the column wall during the first coating stage of Trials 2 and 3. The estimations of coat thickness shown in Figure 4-2 assumed a perfectly uniform, evenly distributed film coat and did not account for variations in thickness between or within pellets. The differences between the measured and theoretical pellet coat thickness highlight the need for a method to monitor the coating. Although easily made,



measurements of the amount of coating sprayed onto the bed do not provide accurate and reliable indications of the pellet coating.

SEM images of the pellet surface (Figure 4-3) further confirmed the formation of a film coat. Figures 4-3a and 4-3b show the uncoated smooth surface of a glass pellet at 1000x and 5000x magnification, while Figures 4-3c to 4-3f identify the formation of sugar crystals on the outside of the pellet surface. Specifically, Figures 4-3c and 4-3d show a less coated pellet, as the surface is not uniformly coated and smooth uncoated areas are present. Figures 4-3e and 4-3f show a completely coated surface. The surface morphology is much rougher for the coated pellets compared to the smooth surface of the uncoated pellets, potentially influencing pellet flowability.

Figure 4-4 shows passive acoustic emissions measured near the surface of the fluidized pellet bed. The raw signals showed changes with time; after each coating stage the amplitude of the signals increased. The changes in acoustic emission amplitudes are summarized in Figure 4-5. The pellets increased in mass as they were coated, increasing pellet momentum which impacted collisions with other pellets or the column wall; this produced larger vibrations measured by the microphone as passive acoustic emissions with larger amplitudes.

As shown in Figure 4-5, the amplitude of the acoustic emissions also increased with superficial gas velocity. Pellet velocities within the fluidized bed increased with superficial gas velocity. This increased pellet momentum which led to larger vibrations when the pellets collided with other pellets or the column wall, resulting in larger emissions amplitudes. Therefore, the passive acoustic emissions were affected by both changes in the pellets and the fluidized bed dynamics.

The change in acoustic emissions as coating progressed corresponded to an increase in pellet size and therefore mass. Early work by Leach and Rubin in the 1970's found comparable results, as they were able to use acoustic emissions to measure particle size and particle size distribution [26-30]. The basis of their work identified an inverse relationship between acoustic emission frequencies to particle size; particles of different diameters produced different beat frequencies reflected in the acoustic emissions.

Supplemental experiments were conducted to evaluate the effect of a change in mass on the passive acoustic emissions. Acoustic emissions from collisions using uncoated pellets of 1000  $\mu\text{m}$ , 2000  $\mu\text{m}$ , 3000  $\mu\text{m}$  and 4000  $\mu\text{m}$  in diameter were examined. The passive acoustic emissions were measured for a single uncoated glass pellet colliding with the metal plate. As shown in Figure 4-6, the amplitude of the measured emissions increased almost linearly with increasing pellet mass. Theoretical equations confirm kinetic energy generated from particle vibrations to be proportional to mass [32]. As well, a more recent study by Hou et al. related particle momentum to particle-equipment collisions reflected in the acoustic emissions profiles [33].

To further simulate pellet-pellet and pellet-wall collisions within the fluidized bed, groups of 10 pellets were dropped simultaneously onto the plate. Again, larger acoustic emission amplitudes were proportional to pellet mass. The increase in the maximum emission amplitudes compared to the single pellet measurements however, was not linearly proportional to the number of pellets, shown in Figure 4-7. However, the number and duration of the fluctuations of the signals increased significantly with the number of pellets. All 10 pellets would not have impacted perfectly simultaneously with the metal plate. This would have created multiple vibrations with the potential for each contribution to amplify or dampen other vibrations. In addition, vibrations from any pellet-pellet collisions may have been detected and contributed to the measured acoustic emissions. The ability to detect differences in collisions of pellets with only small changes in mass or numbers of pellets highlights the sensitivity of acoustic emission measurements and the potential for monitoring the thin film coating that needs to be applied to pellets for pharmaceutical multiple unit dosage forms.

The pellet drop tests were repeated using a sugar coated metal plate to simulate the effect of the loss of coating on the column wall on the measured acoustic emissions. The emissions from the pellets colliding with the metal plate were comparable, within acceptable error, for both cases shown in Figures 4-8a and 4-8b. The sugar coating on the metal plate was concluded to have minimal influence on the attenuation of the acoustic emissions. Therefore, the measured passive acoustic emissions reflected pellet changes and fluidized bed dynamics with minor interference from the coating solution on the

column wall; the change in measured acoustic emissions represents the additional coating on the pellets not the coating on the column wall. This was further confirmed in preliminary experiments involving an empty column with no fluidizing air; acoustic emissions showed no change and appeared constant as the atomized spray was turned on and off.

The fluidization quality of the pellet bed changed with time. The mass of the pellets increased with coating. At a constant superficial gas velocity, the fluidization quality then decreased slightly as the velocity of the pellets within the bed correspondingly decreased. It is important to maintain a superficial gas velocity sufficiently above critical values to ensure that the pellets are constantly in motion to promote uniform distribution of the coating through the bed and onto individual pellets, and to promote uniform drying of the coating. As the pellets are coated, there are two opposing effects influencing the acoustic emissions: the increase in mass of the pellets versus the decrease in the velocity of the pellets. However, as shown by the increase in amplitude of the emissions with each coating stage (Figure 4-4) the change in pellet mass has a dominant effect over any decrease due to the drop in fluidization quality. Therefore, provided that a sufficiently high superficial gas velocity is maintained, monitoring changes in the acoustic emissions amplitude will primarily reflect pellet coating rather than fluidization quality.

Application of the coating solution changed the surface properties of the pellets in addition to changing their mass and size. Surface changes affected particle-particle interaction, which in turn influenced fluidization. To estimate the effect of the coating solution on surface interactions, samples were removed from the fluidized bed and assessed for flowability. Samples were removed immediately after a coating period, halfway into a drying period and at the end of a drying period. These samples were referred to as *wet*, *half wet* and *dry*, respectively. As shown in Figure 4-9, the flowability as estimated using the avalanche time, varied with coating stage. Immediately after a coating period, the pellets were wet from the coating solution. The avalanche time increased from the uncoated pellets time indicating a decrease in flowability. The viscosity of the coating film was approximately the same as the coating solution, 0.00146 Pa s [34]. The film was somewhat sticky, increasing cohesion or friction between the

pellets. However, as the water content within the film was still high, the film also provided some lubrication between the pellets, partially balancing the reduction in flowability. The large range in avalanche times for the wet samples from Coat 1 partially reflected that the coating had only started and not all the pellets may have been coated and/or uniformly coated. As the film dried, the water content of the film decreased, and the film viscosity increased. The cohesion between the particles increased while the lubrication decreased resulting in further reductions in flowability. The dried film coat on the pellets contained almost no water. The film coat was therefore no longer sticky and the flowability stabilized or increased. The flowability, however, did not improve to the level of uncoated pellets. As shown in Figure 4-3, the surface of the coated pellets was not as smooth as uncoated pellets. The relative particle-particle friction would be higher inhibiting flow. The trend in flowability within each coating stage remained similar, but the overall flowability decreased with each coating stage. As shown in Figure 4-3, as the film thickness increased, the coated pellet surface became more irregular. This increased friction each time further inhibiting flow.

The acoustic emissions signal of fluidized Cellets<sup>®</sup> is shown in Figure 4-10. The average amplitude of the signal was lower compared to the amplitude of fluidized glass pellets. This was expected as the Cellets<sup>®</sup> have a much lower density and lower overall mass. Although the size of the Cellets<sup>®</sup> was comparable, a much larger distribution was observed ranging from 1000 -1400  $\mu\text{m}$  in diameter. As well, Cellet<sup>®</sup> sphericity appeared to vary. These differences affected fluidization resulting in the observed shifts in the raw signal compared to the more constant signal acquired for the fluidized glass pellets. In regards to coating, the Cellets<sup>®</sup> are expected to produce a similar trend in the acoustic emissions profile; the amplitude would increase as coating progressed but would initially start at a lower value.

## 4.5 Conclusions

Inaccurate and unreliable measurements of the pellet film coat thickness highlight the need for developing a monitoring and control method to determine the desired coating end-point in a fluidized bed. The film coat thickness is a critical parameter in the design of multiple unit dosage forms, to ensure the appropriate drug release profile is achieved.

Passive acoustic emissions monitoring provides a non-invasive method of acquiring on-line and real-time measurements reflecting process information. A microphone attached flush to the exterior of the column at the height of the fluidized pellet bed showed changes in the amplitude of the passive acoustic emissions, related to pellet film coat thickness. Supplemental experiments confirmed acoustic emissions amplitudes to increase with increasing pellet mass. Furthermore, the acoustic emissions measurements were shown to detect differences in pellet collisions, highlighting the sensitivity of such measurements for monitoring thin film coatings. Provided the pellets were sufficiently fluidized, the change in acoustic emissions amplitude reflected an increase in film coat thickness, identifying the potential for applying passive acoustic emissions to monitor pellet film coatings and to detect an optimal coating end-point.

## 4.6 References

- [1] E. Teunou, D. Poncelet, Batch and continuous fluid bed coating – review and state of the art, *Journal of Food Engineering*, 53 (2002) 325-340.
- [2] F. Depypere, P. Van Oostveldt, J.G. Pieters, K. Dewettinck, Quantification of microparticle coating quality by confocal laser scanning microscopy (CLSM), *European Journal of Pharmaceutics and Biopharmaceutics*, 73 (2009) 179-186.
- [3] G. Perfetti, E.V.d. Castele, B. Rieger, W.J. Wildeboer, G.M.H. Meesters, X-ray micro tomography and image analysis as complementary methods for morphological characterization and coating thickness measurement of coated particles, *Advanced Powder Technology*, 21 (2010) 663-675.
- [4] M.-J. Lee, D.-Y. Seo, H.-E. Lee, I.-C. Wang, W.-S. Kim, M.-Y. Jeong, G.J. Choi, In line NIR quantification of film thickness on pharmaceutical pellets during a fluid bed coating process, *International Journal of Pharmaceutics*, 403 (2011) 66-72.

- [5] C.V. Liew, L.K. Wang, P. Wan Sia Heng, Development of a visiometric process analyzer for real-time monitoring of bottom spray fluid-bed coating, *Journal of Pharmaceutical Sciences*, 99 (2010) 346-356.
- [6] P. Pandey, M. Katakdaunde, R. Turton, Modeling weight variability in a pan coating process using Monte Carlo simulations, *AAPS PharmSciTech*, 7 (2006) E2-E11.
- [7] M. Hemati, R. Cherif, K. Saleh, V. Pont, Fluidized bed coating and granulation: influence of process-related variables and physicochemical properties on the growth kinetics, *Powder Technology*, 130 (2003) 18-34.
- [8] D. Jones, Air Suspension Coating for Multiparticulates, *Drug Development and Industrial Pharmacy*, 20 (1994) 3175-3206.
- [9] K. Naelapää, P. Veski, J.G. Pedersen, D. Anov, P. Jørgensen, H.G. Kristensen, P. Bertelsen, Acoustic monitoring of a fluidized bed coating process, *International Journal of Pharmaceutics*, 332 (2007) 90-97.
- [10] M. Možina, D. Tomažević, S. Leben, F. Pernuš, B. Likar, Digital imaging as a process analytical technology tool for fluid-bed pellet coating process, *European Journal of Pharmaceutical Sciences*, 41 (2010) 156-162.
- [11] M. Andersson, B. Holmquist, J. Lindquist, O. Nilsson, K.-G. Wahlund, Analysis of film coating thickness and surface area of pharmaceutical pellets using fluorescence microscopy and image analysis, *Journal of Pharmaceutical and Biomedical Analysis*, 22 (2000) 325-339.

- [12] F.L. Laksmana, L.J. Van Vliet, P.J.A. Hartman Kok, H. Vromans, H.W. Frijlink, K. Van der Voort Maarschalk, Quantitative Image Analysis for Evaluating the Coating Thickness and Pore Distribution in Coated Small Particles, *Pharmaceutical Research*, 26 (2009) 965-976.
- [13] T. Sovány, K. Nikowitz, G. Regdon Jr, P. Kása Jr, K. Pintye-Hódi, Raman spectroscopic investigation of film thickness, *Polymer Testing*, 28 (2009) 770-772.
- [14] Food and Drug Administration, Guidance for Industry: PAT a framework for innovative pharmaceutical development, manufacturing and quality assurance, DHHS, Rockville, MD, 2004.
- [15] A. Bogomolov, M. Engler, M. Melichar, A. Wigmore, In-line analysis of a fluid bed pellet coating process using a combination of near infrared and Raman spectroscopy, *Journal of Chemometrics*, 24 (2010) 544-557.
- [16] Y. Kato, D. Sasakura, T. Miura, A. Nagatomo, K. Terada, Evaluation of Risk and Benefit in the Application of Near-Infrared Spectroscopy to Monitor the Granule Coating Process, *Pharmaceutical Development and Technology*, 13 (2008) 205-211.
- [17] L.E. Kinsler, A.R. Frey, A.B. Coppens, J.V. Sanders, *Fundamentals of Acoustics*, Wiley-VCH1999.
- [18] J. W.R. Boyd, J. Varley, The uses of passive measurement of acoustic emissions from chemical engineering processes, *Chemical Engineering Science*, 56 (2001) 1749-1767.

- [19] H. Tsujimoto, T. Yokoyama, C.C. Huang, I. Sekiguchi, Monitoring particle fluidization in a fluidized bed granulator with an acoustic emission sensor, *Powder Technology*, 113 (2000) 88-96.
- [20] E.M. Hansuld, L. Briens, J.A.B. McCann, A. Sayani, Audible acoustics in high-shear wet granulation: Application of frequency filtering, *International Journal of Pharmaceutics*, 378 (2009) 37-44.
- [21] E.M. Hansuld, L. Briens, A. Sayani, J.A.B. McCann, An investigation of the relationship between acoustic emissions and particle size, *Powder Technology*, 219 (2012) 111-117.
- [22] L. Briens, D. Daniher, A. Tallevi, Monitoring high-shear granulation using sound and vibration measurements, *International Journal of Pharmaceutics*, 331 (2007) 54-60.
- [23] S. Matero, S. Poutiainen, J. Leskinen, K. Järvinen, J. Ketolainen, S.P. Reinikainen, M. Hakulinen, R. Lappalainen, A. Poso, The feasibility of using acoustic emissions for monitoring of fluidized bed granulation, *Chemometrics and Intelligent Laboratory Systems*, 97 (2009) 75-81.
- [24] D. Vervloet, J. Nijenhuis, J.R. van Ommen, Monitoring a lab-scale fluidized bed dryer: A comparison between pressure transducers, passive acoustic emissions and vibration measurements, *Powder Technology*, 197 (2010) 36-48.



- [25] P. Allan, L.J. Bellamy, A. Nordon, D. Littlejohn, Non-invasive monitoring of the mixing of pharmaceutical powders by broadband acoustic emission, *The Analyst*, 135 (2010) 518-524.
- [26] M.F. Leach, G.A. Rubin, Size analysis of particles of irregular shape from their acoustic emissions, *Powder Technology*, 21 (1978) 263-267.
- [27] M.F. Leach, G.A. Rubin, J.C. Williams, Particle size determination from acoustic emissions, *Powder Technology*, 16 (1977) 153-158.
- [28] M.F. Leach, G.A. Rubin, J.C. Williams, Analysis of gaussian size distribution of rigid particles from their acoustic emission, *Powder Technology*, 19 (1978) 189-195.
- [29] M.F. Leach, G.A. Rubin, J.C. Williams, Analysis of polydisperse systems of rigid particles from acoustic emissions, *Powder Technology*, 19 (1978) 169-176.
- [30] M.F. Leach, G.A. Rubin, J.C. Williams, Particle size distribution characterization from acoustic emissions, *Powder Technology*, 19 (1978) 157-167.
- [31] T. Sheahan, L. Briens, Passive acoustic emissions monitoring of the coating of pellets in a fluidized bed – a feasibility analysis, *Powder Technology*, 283 (2015) 373-379.
- [32] W.F. Donkin, *Acoustics*, Oxford, Clarendon Press, 1884.
- [33] R. Hou, A. Hunt, R.A. Williams, Acoustic monitoring of hydrocyclones, *Powder Technology*, 124 (2002) 176-187.

[34] Hofmann, G, Iscotables: a handbook of data for biological and physical scientists. 7<sup>th</sup> ed. Lincoln, Nebraska: Instrumentation Specialties Company, 1977

## Chapter 5

### 5 General Discussion and Conclusions

The release profile of modified release dosage forms *in vivo* is highly dependent on the properties of the film coat surrounding the pellet core. Conventional techniques used to evaluate pellet coatings require invasive sampling and time consuming off-line analyses. Passive acoustic emissions have been proven as a useful non-invasive monitoring tool with the ability to provide on-line and real-time measurements. Therefore, this research focused on the application of passive acoustic emissions for the monitoring of pellet coating in a top spray fluidized bed. Analyzed acoustic emissions were compared to conventional evaluation techniques. Supplemental experiments were performed to provide a more in depth understanding of the interactions between pellets and the coating solution.

#### 5.1 Acoustic Monitoring

##### 5.1.1 Feasibility Analysis

Building from the work of Naelapää et al. [1], the use of passive acoustic emissions to monitor pellet coating was assessed. Glass pellets were coated in a top spray fluidized bed with an atomized sugar solution. The analysis of pressure fluctuation measurements across the bed confirmed adequate pellet fluidization. Three microphone locations were chosen to acquire the passive acoustic emissions; one suspended in the exhaust of an air outlet at the top of the column and two attached externally to the column wall at the interface of the fluidized pellet bed and liquid spray, and at the grid. Samples were removed periodically from the column through a side sampling port to determine the increase in coat thickness as coating progressed.

The comparison of measured coat thickness values to theoretical estimations showed significant differences indicating the loss of coating solution on the column wall. As well, variations in measured coat thickness values highlighted the difficulty associated with the removal of representative samples from the fluidized bed. Decreased fluidization quality as coating continued was shown to impact coat distribution and uniformity among the

pellets, as well as negatively influencing drying rate. The inaccuracies associated with sampling and off-line testing reaffirmed the need for a more sophisticated monitoring and control method.

To extract relevant process information, statistical and frequency analyses were performed on the acoustic emission measurements. In the interest of automatic and fast computation, a statistical analysis was chosen providing desired process information reflecting changes in the emissions profile at all microphone locations. At the exhaust, the standard deviation of the measured acoustic emissions increased or decreased during the coating and drying periods, identifying the potential to monitor spray performance or for the detection of nozzle clogging. At the interface of the fluidized pellet bed and liquid spray, the standard deviation of the measured acoustic emissions reflected changes corresponding to the spraying and drying zones. As well, the acoustic emissions profile at this location reflected fluidization quality. Large changes in the standard deviation corresponded to good fluidization, associated with excellent distribution of the film coat and effective drying. Small changes in the standard deviations corresponded to poor fluidization, indicating the need to increase the fluidization velocity for improved process conditions. The standard deviation of the acoustic emissions measured at the grid showed a similar profile to the measurements acquired at the interface, but were difficult to relate to process conditions.

Overall, this study confirmed the possibility of using passive acoustic emissions to monitor the coating of pellets in a fluidized bed reflecting process changes.

### 5.1.2 Monitoring of Pellet Coat Thickness

Expanding on the feasibility analysis, the use of passive acoustic emissions to detect film coat thickness was explored corresponding to the potential application of determining a desired coating end-point. Again, glass pellets were coated with a sugar solution in a top spray fluidized bed. The coating was separated into four stages where each stage corresponded to a measured coat thickness value. Acoustic measurements of the dry coated pellets after each coating stage and at varying superficial gas velocities were acquired from a microphone located at the same position on the column as the

microphone used to acquire measurements at the interface in the previous study. Supplemental experiments were performed to simulate different aspects of the process providing additional insight into process behavior and the interactions between pellets and the coating solution.

The measured acoustic emissions reflected changes with time, where the amplitude of the signal increased with each coating stage. As coating progressed, the pellets increased in mass corresponding to increased pellet momentum and pellet collisions, producing larger vibrations reflected in the emissions amplitude. Similarly, the amplitude increased with an increase in superficial gas velocity due to the increased pellet momentum. Overall, changes in pellets and fluidized bed dynamics affected the passive acoustic emissions.

Supplemental experiments simulating process conditions showed an increase in pellet mass to correspond to an increase in the acoustic emissions amplitude for a single pellet colliding with a metal plate. A group of 10 pellets was compared to the collision of a single pellet, where again, an increase in the individual pellet mass corresponded to an increase in the acoustic emissions amplitude. In this case, the amplitude was not linearly proportional to the number of pellets impacting the metal plate, but the signal did reflect an increase in the number and duration of fluctuations when a group of pellets collided. This showed the sensitivity of acoustic emissions measurements to detect differences in pellet collisions regarding small changes in the mass or number of pellets, which is important for monitoring thin film coatings. The addition of sugar to the metal plate was shown to have a minimal impact on the attenuation of the acoustic emissions, identifying measured acoustic emissions to reflect the coating on the pellets and not the coating solution on the column wall.

The coating solution was shown to alter the surface properties of the pellets and to affect pellet flowability as the wet coating solution dried. The sticky film coat decreased pellet flowability due to an increase in cohesion or friction between pellets, impacting fluidization quality. Due to the opposing forces within the fluidized bed it is important to maintain proper fluidization. In this case, if the bed is sufficiently fluidized the amplitude

of the acoustic emissions measurements should reflect pellet changes rather than fluidization quality.

Overall, passive acoustic emissions were able to detect an increase in film coat thickness and showed potential for identifying a desired coating end-point.

## 5.2 Relevance to the Pharmaceutical Industry

The Food and Drug Administration's new guidelines call for the development of process analytical technologies (PATs) to improve process manufacturing, development and quality assurance [2]. The implementation of more sophisticated monitoring and control methods would reduce the number of failed batches and loss of product, improving process cost-effectiveness. This study has identified such potential for the application of passive acoustic emissions monitoring in regards to the manufacture of coated pellets for multiple unit dosage forms with modified drug release.

Typical methods used to evaluate film coatings are invasive to the process and require extensive and unreliable off-line analyses. Monitoring the process non-invasively using passive acoustic emissions can provide real-time information reflecting process changes. The measurements may indicate decreased fluidization quality, nozzle clogging or a coat thickness value, identifying to the operator if they should continue, modify or end the coating process. Such real-time feedback allows for better process control corresponding to a more efficient manufacturing process as desired by the pharmaceutical industry.

## 5.3 Future Work

This research focused on a re-usable model system consisting of glass pellets coated with a sugar solution. The glass pellets were chosen due to their similarities to microcrystalline cellulose starter cores, Cellets<sup>®</sup>, used commercially for pharmaceutical multiple unit dosage forms. The acoustic emission measurements of fluidized Cellets<sup>®</sup> showed lower overall amplitudes compared to the amplitude of fluidized glass pellets. It is hypothesized that similar results would be observed for the coating of Cellets<sup>®</sup> but the produced emissions would be of a smaller scale due to the much lower density and overall mass of the Cellets<sup>®</sup>. Therefore, future work should include the analysis of coating Cellets<sup>®</sup>, or

pellets of different formulations, to confirm the proposed hypothesis. As well, it would be of interest to coat the pellets with different solution formulations. Such work would focus on the study of a real system representative of what is used in the pharmaceutical industry.

This work has confirmed the feasibility for using passive acoustic emissions for monitoring the coating of pellets and for detecting increases in film coat thickness. Additional work is required to translate the technique from a potential monitoring method to implementation in pharmaceutical manufacturing processes. FDA regulatory approval has made the introduction of new technologies into the pharmaceutical industry slow and difficult. For industrial application improvements to the method's robustness and ability to reliably monitor and control the coating process is required. Continued research is necessary to further confirm the ability of passive acoustic emissions monitoring to minimize human and process error, improve product quality and process efficiency, and reduce waste or the number of discarded batches. This is needed to obtain regulatory approval and would be the main focus of continued work. This may include focusing on different frequency ranges within the signal to relate the emissions profile to different aspects of the process. Currently we have shown the acquired emissions reflect process changes but additional analysis is necessary to further relate specific aspects of the signal to the coating process in the interest of process monitoring and control.

## 5.4 Conclusions

Passive acoustic emissions present a potential tool for monitoring the coating of pellets in a fluidized bed. The non-invasive nature of the method involves the attachment of microphones externally to a unit, which acquires real-time process information to be used for process monitoring and control. This work showed the ability of passive acoustic emissions to reflect process information by identifying changes in fluidization quality, information on nozzle performance and the detection of changes in film coat thickness for the potential determination of a coating end-point. Different information may be extracted from the signal depending on the type of analysis used. Additional research is required to continue the development of passive acoustic emissions monitoring for

industrial fluid bed coating applications, with the potential to improve overall product quality and process cost-effectiveness.

## 5.5 References

[1] K. Naelapää, P. Veski, J.G. Pedersen, D. Anov, P. Jørgensen, H.G. Kristensen, P. Bertelsen, Acoustic monitoring of a fluidized bed coating process, *International Journal of Pharmaceutics*, 332 (2007) 90-97.

[2] Food and Drug Administration, *Guidance for Industry: PAT a framework for innovative pharmaceutical development, manufacturing and quality assurance*, DHHS, Rockville, MD, 2004.



## Curriculum Vitae

**Taylor Sheahan**

### **Post Secondary Education and Degrees:**

- |   |                  |
|---|------------------|
| <b>Master of Engineering Science<br/>Biomedical Engineering</b>                                 | <b>2013-2015</b> |
| The University of Western Ontario, London, Ontario Canada                                       |                  |
| MESc Thesis Title: <i>Passive acoustic emissions monitoring of fluidized bed pellet coating</i> |                  |
| <b>Bachelor of Science Engineering<br/>Chemical Engineering (with First Class Honours)</b>      | <b>2009-2013</b> |
| Queen's University, Kingston, Ontario Canada  |                  |

### **Awards and Accomplishments:**

- |  |                  |
|--|------------------|
| <b>Graduate Research Scholarship</b>                                   | <b>2013-2015</b> |
| The University of Western Ontario, London, Ontario Canada              |                  |
| <b>Dean's List</b>   | <b>2009-2013</b> |
| Faculty of Engineering<br>Queen's University, Kingston, Ontario Canada |                  |
| <b>Entrance Award (Renewable Scholarship)</b>                          | <b>2009-2013</b> |
| Faculty of Engineering<br>Queen's University, Kingston, Ontario Canada |                  |
| <b>Science 1946 Memorial Scholarship in Applied Science</b>            | <b>2009</b>      |
| Faculty of Engineering<br>Queen's University, Kingston, Ontario Canada |                  |

### **Related Work Experience**

- |   |                  |
|---|------------------|
| <b>Graduate Research Student, Biomedical Engineering</b>        | <b>2013-2015</b> |
| The University of Western Ontario, London, Ontario Canada       |                  |
| <b>Teaching Assistant, Chemical and Biochemical Engineering</b> | <b>2013-2015</b> |
| The University of Western Ontario, London, Ontario Canada       |                  |

**Publications and Conference Proceedings:**

Sheahan, T. and Briens, L. (2015). *Passive acoustic emissions monitoring of the coating of pellets in a fluidized bed – A feasibility analysis*. **Powder Technology**, 283, 373-379.

Sheahan, T. and Briens, L. (2015) *Passive acoustic emissions monitoring of pellet coat thickness in a fluidized bed*. Accepted for publication in **Powder Technology**

**Sheahan, T** and Briens, L. (2014). *Monitoring fluidized bed coating of pharmaceutical pellets*. **64<sup>th</sup> Canadian Chemical Engineering Conference**. Niagara Falls, Ontario Canada, Oct. 2014.